

# ALL-NEW JAGUAR XF



THE ART OF PERFORMANCE







BY APPOINTMENT TO  
HM THE QUEEN  
MANUFACTURERS OF  
MOTOR VEHICLES  
JAGUAR LAND ROVER LIMITED  
COVENTRY



BY APPOINTMENT TO  
HRH THE DUKE OF EDINBURGH  
MANUFACTURERS OF  
MOTOR VEHICLES  
JAGUAR LAND ROVER LIMITED  
COVENTRY



BY APPOINTMENT TO  
HRH THE PRINCE OF WALES  
MANUFACTURERS OF  
MOTOR VEHICLES  
JAGUAR LAND ROVER LIMITED  
COVENTRY



## JAGUAR

# THE ART OF PERFORMANCE

Every day we push performance to its limit. Our performance. Our cars' performance.  
We innovate, we engineer, we design. We master rules and then break them.  
Only to push further. Past the limits of convention. This is when performance becomes art.

Jaguar. The Art of Performance.







## CONTENTS

### INTRODUCTION

The Concept of XF	07
XF - The Facts	08

### DESIGN

Exterior Principles	10
Exterior Aerodynamics	12
Interior	17
Interior Space	19

### PERFORMANCE

Engines	20
Automatic Transmission	22
Manual Transmission	23
Advanced Aerodynamics	24
Lightweight Aluminium Architecture	27
Chassis and Suspension	28
Advanced Driving Dynamics	31

### DRIVING TECHNOLOGY

All Surface Progress Control	32
Advanced Drivetrain Technology	35
Torque Vectoring	36
Stability and Control	39
Head-Up Display	41

### INFOTAINMENT

InControl Technologies	42
InControl Touch and InControl Connect	45
InControl Touch Pro and InControl Connect Pro	47
Audio	48

### SAFETY AND EFFICIENCY

Advanced Driver Assistance	50
Efficient Technologies	52

### PERSONALISATION

XF - Your Choice	54
Choose your Engine	56
Choose your Model	58
Choose your Options	60
Choose your Colour	66
Choose your Wheels	68
Choose your Interior	70
Choose your Jaguar Accessories	88
Technical Specifications	90
Dimensions	92

### JAGUAR WORLD

Jaguar Experience	94
The World of Jaguar	96
Glossary and Legal Information	98



Scan to find out more about the all-new Jaguar XF.

VEHICLE SHOWN: XF PRESTIGE IN RHODIUM SILVER WITH 19" RAZOR ALLOY WHEELS





## INTRODUCTION

# THE CONCEPT OF XF

XF is all-new. Building on the success of Jaguar's most award-winning car ever. Possessing an unrivalled combination of style and substance. Delivering an utterly seductive blend of design, dynamics and refinement to create a car that offers both excitement and efficiency. All enhanced by state-of-the-art technologies that keep you safe, connected and entertained.

XF sits in the Jaguar saloon range between XE's taut athleticism and the supreme luxury of XJ. The fusion of these outstanding Jaguar attributes is what creates XF - the most dynamic, premium business saloon of its generation.

VEHICLE SHOWN: XF S IN GLACIER WHITE WITH 20" LABYRINTH ALLOY WHEELS, OPTIONAL LED HEADLIGHTS, BLACK PACK AND SUNROOF



## XF - THE FACTS

An outstanding combination of advanced engineering, the latest technology and contemporary design sets XF apart.

### ADVANCED AERODYNAMICS

XF is capable of achieving a drag coefficient of just Cd. 0.26, one of the lowest in its class. Even the underside of the car is aerodynamically designed to be as smooth as possible, while apertures in the front bumper optimise airflow through the wheel arches. XF cuts through the air, reducing wind noise for enhanced refinement and improved efficiency.

---

### BREADTH OF PERFORMANCE

The XF range delivers a new generation of performance engines. From CO<sub>2</sub> emissions and fuel economy as low as 104g/km and 4.0 l/100km respectively, to a top speed limited to 250km/h and 0-100km/h in 5.3 seconds - there is an XF for every driver.

---

### JAGUAR CARE\*

XF is now offered with a new unlimited mileage, three year warranty and three years' servicing programme at no additional cost. We call this programme Jaguar Care. It makes XF's overall cost of ownership one of the lowest in its class.



\*Selected European markets only.  
Some features described here are optional and market dependent.

VEHICLE SHOWN: XF S IN GLACIER WHITE WITH 20" LABYRINTH ALLOY WHEELS,  
OPTIONAL LED HEADLIGHTS, BLACK PACK, SUNROOF AND PRIVACY GLASS

### CRAFTSMANSHIP AND SPACE

Contemporary craftsmanship and a beautiful, luxurious interior with the space to stretch out and enjoy every journey. Compared with the previous XF rear knee room has increased by 24mm, making it best in class. Rear legroom has increased by 15mm and rear headroom has risen by up to 27mm\*\*, all adding up to greater comfort and wellbeing for passengers.

\*\*Applicable to XFs not fitted with optional sunroof.

---



### **LIGHTWEIGHT ALUMINIUM ARCHITECTURE**

Jaguar's Lightweight Aluminium Architecture helps to make XF lighter, stronger and 28 percent stiffer than the previous XF. It is up to 190kg lighter than its predecessor, improving handling, performance and efficiency.

### **ADDED INTELLIGENCE**

Innovative technologies make every drive easier and safer. XF offers adaptive LED headlights, Traffic Sign Recognition with Adaptive Speed Limiter, Lane Keep Assist with Driver Condition Monitor, Autonomous Emergency Braking, Adaptive Cruise Control with Queue Assist and Advanced Park Assist.



### **ADVANCED DRIVETRAIN TECHNOLOGY**

XF offers Jaguar's unique All Wheel Drive with Intelligent Driveline Dynamics and Adaptive Surface Response (ASR). This maximises the legendary Jaguar handling, agility and ride, and gives added confidence in all conditions.

### **ALWAYS CONNECTED**

Every drive in XF is enhanced by InControl technologies. InControl is a suite of products and services that connects you with your XF and links XF to the wider world. It ensures you are always in touch.



## DESIGN EXTERIOR PRINCIPLES



DESIGN  
PURITY

ADAPTIVE  
LED HEADLIGHTS

VEHICLE SHOWN RIGHT: XF S IN GLACIER WHITE WITH 20" LABYRINTH ALLOY WHEELS,  
OPTIONAL SUNROOF, LED HEADLIGHTS, BLACK PACK AND SURROUND CAMERA

**"It's about paring it down to the bare essentials. Good designers have always said less is more."**

Ian Callum, Jaguar Design Director.

XF demonstrates the Jaguar principles of design purity. Strong lines radiate dynamic character and enhance its capabilities - be it improving aerodynamics, visibility, stability or safety. XF is available with adaptive LED headlights\* featuring Jaguar signature J-Blade Daytime Running Lights to give XF a striking on-road presence. The quality of LED light is close to daylight, helping your eyes to distinguish objects more easily and reducing fatigue at night.

\*Optional feature, Xenon or Halogen headlights are also available depending on the model chosen.





# EXTERIOR AERODYNAMICS

 **F-TYPE  
INSPIRED DESIGN**

**AERODYNAMIC  
DESIGN**

At the rear, XF's tail lights feature a distinctive, Jaguar F-TYPE inspired, double roundel and intersecting horizontal detail. The LED brake lights are not only brighter than halogen bulbs, they use less energy - contributing to XF's overall drive for greater efficiency. LEDs also illuminate faster - so following drivers can react more quickly to XF's braking. Within the tail lights is a pinstripe graphic - one of XF's many exquisite finishing touches.

XF's sweeping exterior design is naturally aerodynamic. Its advanced form enhances handling, dynamics and refinement. Even the boot lid's height and pitch, as well as its overall curvature and subtle spoiler, are designed to reduce drag and increase downforce. For example, the body generates as much as 50kg of extra downforce at 160km/h for greater stability and helps XF maintain its connection with the road.

VEHICLE SHOWN: XF PRESTIGE IN RHODIUM SILVER WITH 19" RAZOR ALLOY WHEELS

















## INTERIOR



**DRAMATIC START-UP  
SEQUENCE**

**CONTEMPORARY  
CRAFTSMANSHIP**

Open XF's door and the Start button entices you inside. Pulsing with a heartbeat it creates an emotional connection between driver and machine. Its 72 per minute double beat is the same as a jaguar cat at rest. XF is poised, ready for action. Now push the Start button. The car awakens and its mood lighting illuminates. With perfect choreography, air vents rotate open, the JaguarDrive Selector rises smoothly, the engine growls - all inspiring you to anticipate the drive ahead.

XF's interior offers outstanding comfort, a sense of wellbeing and a wealth of choice. The number of switches and buttons has been reduced to keep the look clean and tidy, as well as making them easy to use. Whichever XF interior combination you choose, materials used are always of the highest quality. Leather and finishes are selected with the greatest care to ensure that, inside XF, everything is luxurious to the touch. Whether you prefer aluminium, carbon fibre, or wood veneer finishes to complement the beautiful selection of leathers, your XF will always look and feel just right.

INTERIOR SHOWN LEFT AND PREVIOUS PAGE: XF S FEATURING LIGHT OYSTER/JET SEAT WITH JET UPPER FACIA WITH CONTRAST STITCH, JET CARPET AND JET HEADLINING. OPTIONAL EQUIPMENT FITTED





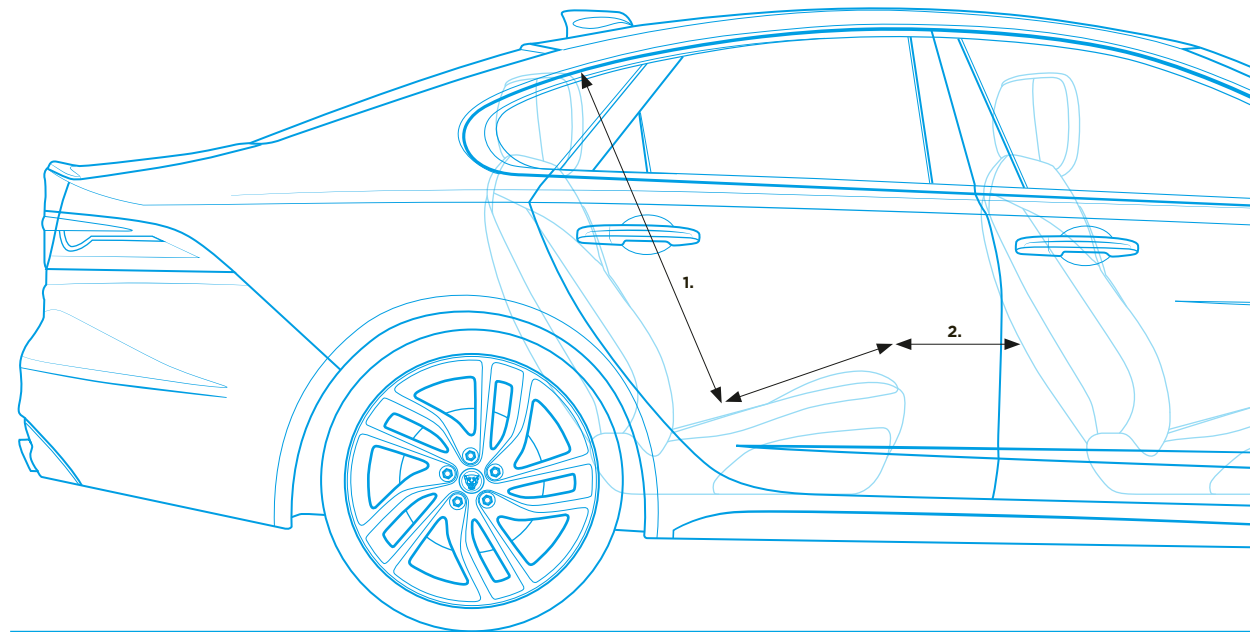

1. Headroom 970mm 2. Knee room 87mm

## INTERIOR SPACE

### CLASS-LEADING REAR KNEE ROOM

The rear of XF's cabin is a destination of luxury, choice and space. Compared with the previous XF, rear knee room has increased by 24mm, making it best in class. Rear legroom has increased by 15mm and rear headroom has risen by up to 27mm\*, all adding up to greater comfort and wellbeing for passengers. Building on the drama of its predecessor's interior, mood lighting also enhances XF's atmosphere. Opt for Configurable Interior Mood Lighting and you'll have a choice of ten interior colours. The choice continues with optional four-zone air conditioning, giving individual passengers the opportunity to set their own temperature and airflow. Keeping your car comfortable regardless of the conditions outside, XF's air conditioning system has undergone punishing real world tests in ambient temperatures ranging from 50°C to -30°C. XF's interior is flexible. You can choose the 40:20:40 seating configuration for increased volume and versatility. Whatever you want, whenever you need it, XF offers it all.

\*Applicable to XFs not fitted with optional sunroof.

INTERIOR SHOWN: XF S FEATURING LIGHT OYSTER/JET SEAT WITH CONTRAST STITCH, JET CARPET AND JET HEADLINING

## PERFORMANCE ENGINES



INGENIUM ENGINES

STOP/START TECHNOLOGY\*

XF offers a choice of refined, efficient diesel or petrol engines - all delivering a dynamic driving experience and responsive Jaguar performance. XF's engines are equipped with Stop/Start technology\* and smart regenerative charging - harvesting kinetic energy from braking to charge the battery - for maximum economy, especially during urban driving.



DIESEL ENGINES FROM

104g/km CO<sub>2</sub>

XF is offered with three diesel engines. Two diesel engines from the new Ingenium range are available: the 2.0 litre i4 turbocharged diesel (163PS) and the 2.0 litre i4 turbocharged diesel (180PS). Ingenium engines from this advanced all-aluminium range are typically 20kg lighter than the equivalent engines from the previous generation - making them more efficient from the outset. They offer effortless performance - immediate high torque delivery and refinement with lower fuel consumption and CO<sub>2</sub> emissions. Also available is the acclaimed 3.0 litre V6 diesel engine. For XF's performance requirements, power has been increased to 300PS with class-leading torque of 700Nm for greater responsiveness, while fuel economy has been improved by up to nine percent.

\*Market dependent



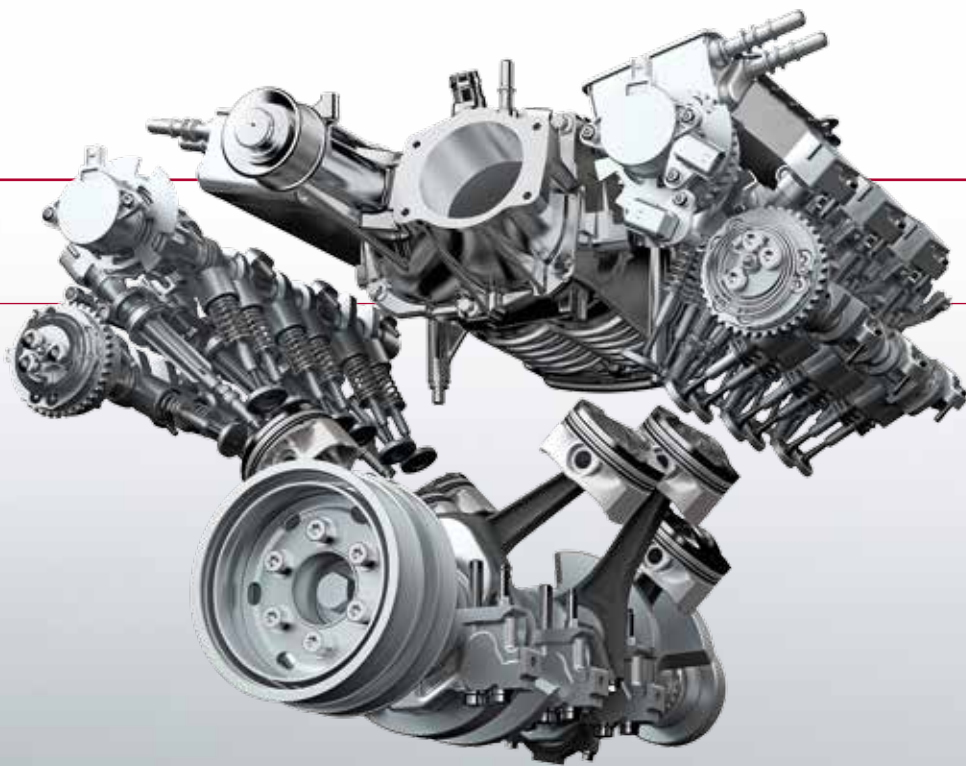

PETROL ENGINES UP TO

**0-100km/h in 5.3 sec**

XF's petrol engines offer power and responsiveness throughout the rev range, while improving efficiency. The 2.0 litre 240PS 4-cylinder turbocharged petrol engine achieves '6-cylinder engine' levels of performance and refinement, from a more compact and economical structure. Shared with Jaguar F-TYPE, the 3.0 litre V6 supercharged petrol engine is available in both 340PS and 380PS versions. The new 380PS engine is capable of 0-100km/h in 5.3 seconds. These all-aluminium engines deliver instant access to high levels of torque at all engine speeds, and a unique soundtrack.

## AUTOMATIC TRANSMISSION

### EIGHT-SPEED AUTOMATIC TRANSMISSION

XF's automatic transmission is highly responsive, smooth and efficient. It delivers rapid shifting for effortless acceleration and overtaking. The intelligent, adaptive system subtly changes the way the throttle delivers power, as well as gearshift patterns, to suit each particular driving circumstance. The unique JaguarDrive Control offers even quicker shifts and sportier kickdown in Dynamic Mode, and earlier up-shifts in Eco Mode. With the automatic transmission the driver can opt to manually control gearshifts, via steering wheel paddles, at the touch of a finger.



# MANUAL TRANSMISSION

## SIX-SPEED MANUAL TRANSMISSION

Choose the six-speed manual gearbox\* for even greater driver involvement. This lightweight, highly advanced unit contributes to XF's outstanding efficiency. Its aluminium alloy casing, hollow shafts and pocketed gears save every gram of weight possible. We use an advanced direct lubrication system to reduce friction and drag for greater efficiency and further weight saving, making this unit the lightest in its class. Specifically designed for the performance requirements of sports cars - it delivers slick, short changes and superb levels of comfort.

\*Manual transmission is available on 2.0 litre i4 163PS (E-Performance) and 2.0 litre i4 180PS Turbocharged Ingenium diesel engines. This is market dependent.





## ADVANCED AERODYNAMICS



LOW DRAG

Cd. 0.26

XF's form has been rigorously optimised for aerodynamic efficiency and stability at motorway speeds. With a drag coefficient as low as Cd. 0.26, XF cuts through the air - reducing fuel consumption and lowering emissions. Every element exploits the exterior's maximum aerodynamic potential while preserving XF's stunning proportions. Vertical apertures in the front bumper outer edges channel air through vents in the wheel arches and out over the front wheels. The airflow then passes along XF's sides where the doors have a flatter cross sectional profile to minimise air pressure differences and contribute further to reduced drag. Even the extensive under body protection is designed to make XF as efficient, economical and refined as possible.

VEHICLE SHOWN: XF PORTFOLIO IN BLACK BERRY WITH 20" MATRIX ALLOY WHEELS AND OPTIONAL LED HEADLIGHTS







# LIGHTWEIGHT ALUMINIUM ARCHITECTURE

 **STRONG** | **RIGID** | **75% ALUMINIUM**

Jaguar has been at the forefront of aluminium car construction for more than a decade. Our latest innovation is Lightweight Aluminium Architecture, which is significantly lighter, stronger and 28 percent stiffer than the structure used in XF's predecessor. Aluminium has also been used to form the body sides, bonnet and front wings of XF. Lightweight aluminium panels are bonded together with a super-strong adhesive, then punched with zinc-coated, boron steel rivets that compress the adhesive to form an airtight bond and a phenomenally strong, rigid structure. This cutting edge process, coupled with the Lightweight Aluminium Architecture, contributes towards weight savings of up to 190kg over the XF it replaces. This weight saving facilitates fuel efficiency up to 4.0 l/100km and reduces CO<sub>2</sub> emissions to as low as 104g/km.

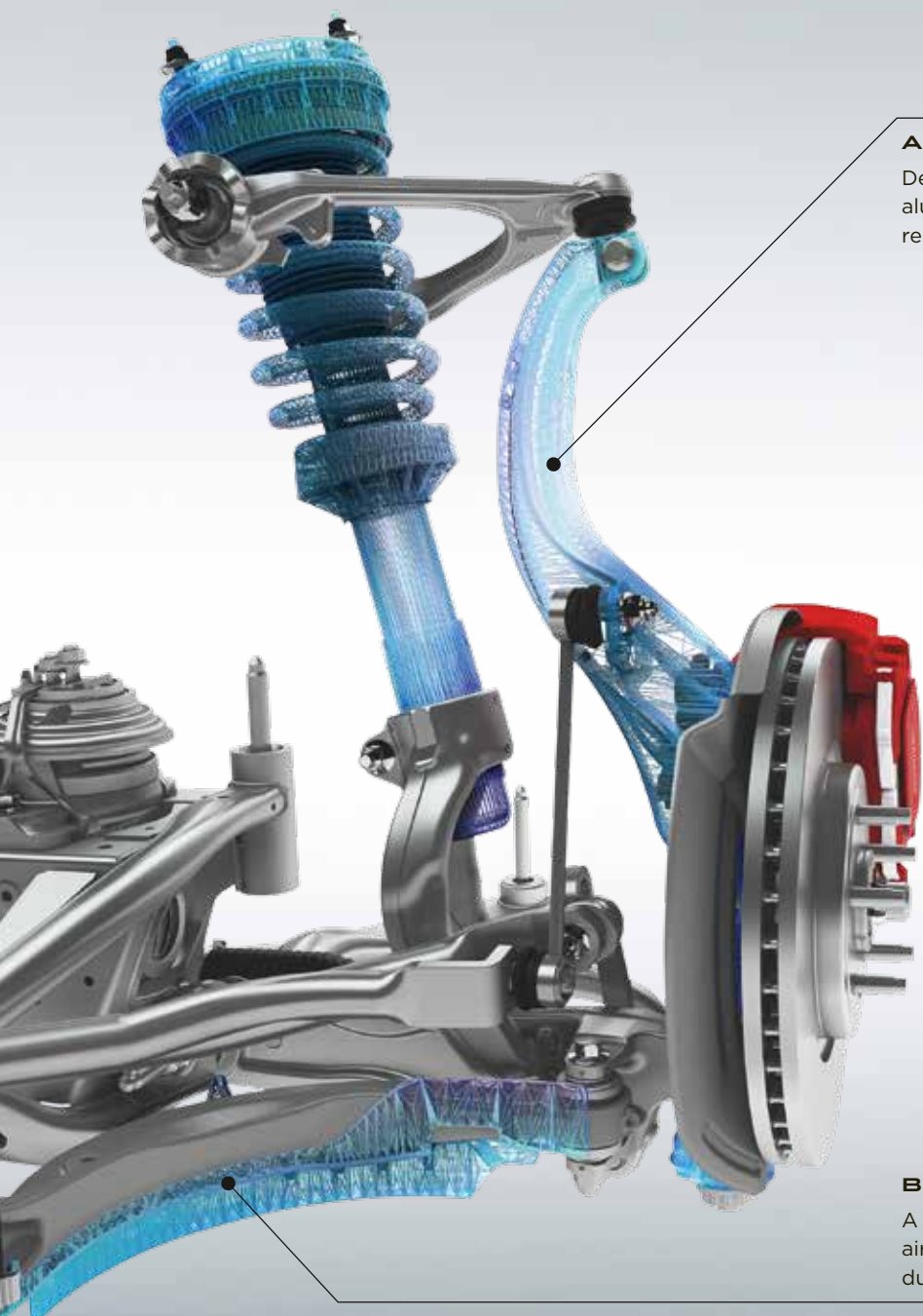

#### ALUMINIUM FRONT KNUCKLE

Designed to optimise stiffness and strength, the lightweight aluminium front knuckle helps improve XF's agility, responsiveness and refinement for sports car-like control.

## CHASSIS AND SUSPENSION



UNIQUE SUSPENSION  
TECHNOLOGY

COMFORTABLE  
AND DYNAMIC

XF responds with agility and performs with dynamism while always maintaining ride comfort - it's a unique balance that makes it a Jaguar. The ideal foundation for these driving dynamics is XF's light, yet exceptionally strong and stiff, Lightweight Aluminium Architecture with its near 50:50 weight distribution.

The sophisticated front and rear suspension systems complete a chassis that achieves a superb combination of sportiness and refinement. Advanced damper technologies - both passive or adaptive - improve ride quality still further and extend XF's breadth of dynamic capability. The suspension's control, agility and feedback give XF the spirit of a sports car.

#### BRAKE SCOOP

A glass-filled polypropylene brake scoop channels air onto the brakes for enhanced brake performance during enthusiastic driving.

### **INTEGRAL LINK REAR SUSPENSION**

Integral Link suspension allows XF to realise a perfect combination of a refined, luxurious ride and sharp, responsive handling. The system, the benchmark for this class of car, separates and independently manages the lateral, longitudinal and vertical forces acting on the suspension for enhanced control and comfort. Many components are forged or hollow-cast in aluminium – the optimum production techniques for strong, lightweight suspension.

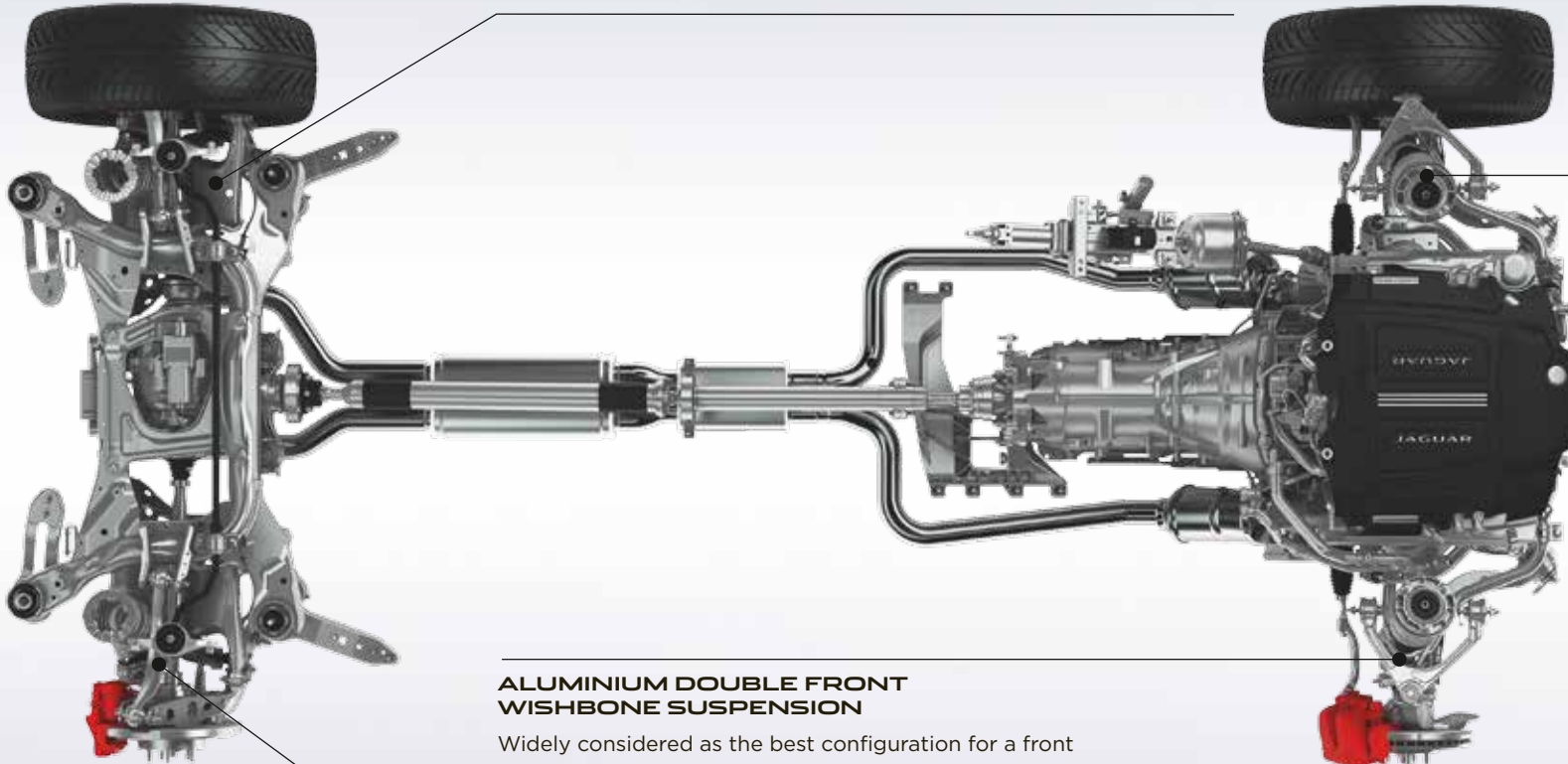

**ADAPTIVE  
DYNAMICS**

### **ALUMINIUM DOUBLE FRONT WISHBONE SUSPENSION**

Widely considered as the best configuration for a front suspension system, the aluminium double wishbone design is modelled closely on F-TYPE's for precise handling and steering response.

### **ADAPTIVE DYNAMICS**

The optional Adaptive Dynamics system delivers both precise dynamics and a supple, luxurious ride by monitoring wheel position and body movements. The Active Dampers adjust the suspension to provide the optimum balance between comfort and refinement at all times.





# ADVANCED DRIVING DYNAMICS



MAXIMISING AGILITY

CONTINUOUSLY ADAPTING

## ADAPTIVE DYNAMICS

Whether you're accelerating on the motorway, cornering on country roads or navigating around town, optional Adaptive Dynamics modifies XF's response to match the conditions and your driving style. It analyses acceleration, cornering, throttle and brake pedal activity, as well as kick down activation. Steering and body movement are also analysed up to 500 times a second. Using this information, electronically controlled adaptive dampers then constantly adjust to optimise the suspension settings and maintain XF's poise and comfort.

## ELECTRIC POWER ASSISTED STEERING

XF's next generation Electric Power Assisted Steering (EPAS) offers outstanding feedback, control and immediate power assistance. It is active on demand - saving power for when you really need it, as well as saving fuel. Allowing sophisticated computer management to adapt the levels of steering support, EPAS gives you fine control at speed and comprehensive assistance during slow manoeuvring. It also enables advanced optional safety features such as Lane Keep Assist and Park Assist.

## CONFIGURABLE DYNAMICS

Bringing technology from F-TYPE, the optional Configurable Dynamics\* system allows you to set up XF's dynamics for suspension, throttle mapping, gearbox shift points and steering to suit your performance driving needs. It is activated when Dynamic Mode is selected in JaguarDrive Control. Dynamic Mode enlivens XF's sporting character. It sharpens throttle response, increases steering weighting and performs gearshifts more quickly and at higher engine speeds. Even more visual drama is brought to the cabin with the instrument dials and optional Configurable Mood Lighting taking on a red glow. Dynamic Mode enhances your connection with XF's sports car performance.

\*Configurable Dynamics is only available with cars fitted with V6 engines and InControl Touch.

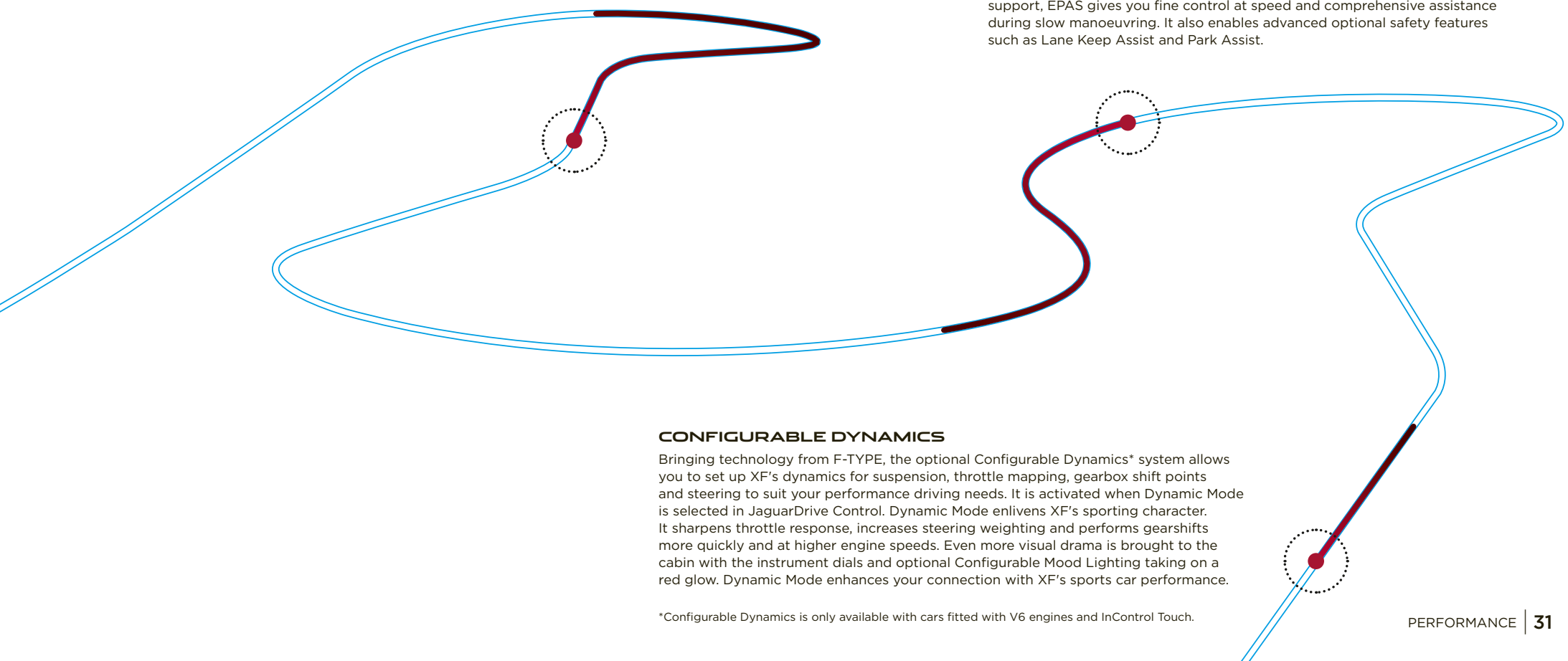



## DRIVING TECHNOLOGY

# ALL SURFACE PROGRESS CONTROL



ADDED DRIVER CONFIDENCE

LOW SPEED CRUISE CONTROL

Unique in this class of car, Jaguar's All Surface Progress Control (ASPC) technology is a low speed cruise control that helps XF to cope with low traction situations. ASPC allows the driver to concentrate on steering the vehicle. Once activated, you use the cruise control buttons to set a 'target' speed of between 3.6km/h and 30km/h. The system then works to achieve and maintain that speed while exerting optimum traction control.

ASPC is standard on all engines fitted with automatic transmissions and gives XF drivers added confidence over slippery, loose or icy surfaces, undulating terrain and even while descending a difficult incline. It helps make XF easy to drive in challenging conditions. ASPC also has a pull-away function allowing XF to progress from rest on slippery surfaces and ascending gradients, as well as a hill descent function that controls vehicle speed on steeper inclines.

With any given set of tyres, ASPC can accomplish comparable levels of traction to that achievable by an expert driver. Fitting All Season or Winter tyres to XF can improve capability on slippery surfaces.



GRAVEL





WET GRASS



SNOW/ICE



WET ROAD



# ADVANCED DRIVETRAIN TECHNOLOGY



ALL WHEEL DRIVE

ADAPTIVE SURFACE RESPONSE

XF's All Wheel Drive (AWD) system delivers confident handling on all surfaces. Our class-leading drivetrain incorporates technologies that offer a reduction in weight and an increase in efficiency compared to previous generation systems. Exclusively developed by Jaguar, the unique Intelligent Driveline Dynamics software features sophisticated algorithms to react intelligently to road conditions for traction on demand. As well as offering a smoother, safer drive, it also consumes less fuel and has lower emissions than permanent AWD. Predictive, as well as reactive, the system helps prevent you from losing traction instead of working to regain it.

On All Wheel Drive vehicles fitted with Adaptive Dynamics, optional Adaptive Surface Response (ASR) recognises differences between surfaces to exploit the maximum available grip. Drawing on Jaguar Land Rover's unrivalled expertise with four-wheel drive systems, ASR constantly monitors the car's environment and adjusts the appropriate engine and brake settings. Once selected, ASR works at all speeds to support you in adverse weather and across challenging surfaces.

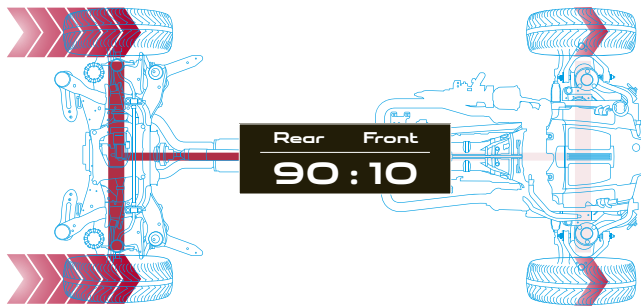

## DRY ROAD SURFACES

In normal driving conditions, virtually all torque is distributed to the rear wheels providing signature Jaguar rear wheel drive performance.

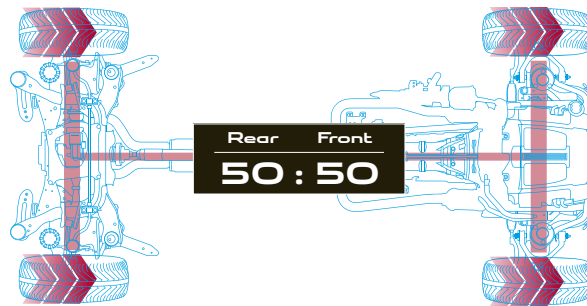

## LOW TRACTION SURFACES

Winter Mode can be selected at the touch of a button to distribute torque 50:50 between front and rear wheels to maximise control in difficult conditions.

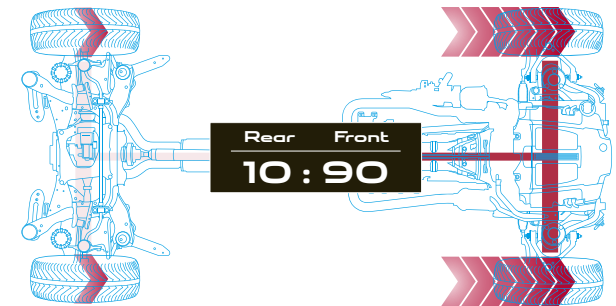

## MIXED LOW TRACTION SURFACES

In conditions where the rear wheels experience a complete loss of traction, over 90 percent of engine torque can be distributed from the rear wheels to the front wheels to provide optimum grip.

VEHICLE SHOWN: XF R-SPORT AWD IN AMMONITE GREY WITH 20" STAR ALLOY WHEELS



**TORQUE VECTORING APPLIES BRAKE PRESSURE TO SLOW THE INSIDE FRONT AND INSIDE REAR WHEELS INDEPENDENTLY.**

---

## TORQUE VECTORING

### MAXIMISED CORNERING CAPABILITY

XF's Torque Vectoring maximises capability through even the tightest corners. Torque Vectoring technology provides controlled independent braking on the individual inside front and rear wheels to add to the turning forces acting on the car. In most conditions more braking pressure is applied to the rear inside wheel as this supports the most increased cornering capability, while the front inside wheel is braked for greater effectiveness and refinement. The result is reduced understeer for sharper turning and more consistent road holding. Torque Vectoring delivers increased sports car-like agility and added driver confidence.

**POWER IS SUSTAINED TO MAINTAIN CONSTANT SPEED OF OUTER WHEELS.**

---

**ADDITIONAL ROTATIONAL FORCE APPLIED AROUND VEHICLE'S AXIS.**

---

VEHICLE SHOWN: XF PRESTIGE IN RHODIUM SILVER WITH 19" RAZOR ALLOY WHEELS AND BI-FUNCTION HID XENON HEADLIGHTS







JAGUAR

473 CAS

XF

2014



# STABILITY AND CONTROL



DYNAMIC STABILITY CONTROL

ENGINE DRAG TORQUE CONTROL

Jaguar's Stability Systems keep XF safely balanced whether you're driving enthusiastically or simply want the assurance of a car that will remain stable in challenging conditions.

**Dynamic Stability Control (DSC)** monitors XF's dynamic behaviour, intervening to maximise vehicle stability and optimising available grip. DSC reduces engine torque and applies braking to the appropriate wheels to correct the car's direction of travel by counteracting understeer or oversteer. XF's DSC system has enhanced understeer control to reduce speed and regain control more effectively.

**Engine Drag Torque Control (EDC)** mitigates the chance of wheel lock-up caused by strong engine braking in slippery conditions. It acts by briefly increasing torque to the wheels as appropriate.

BRAKING APPLIED TO APPROPRIATE WHEELS TO COUNTERACT UNDERSTEER/OVERSTEER

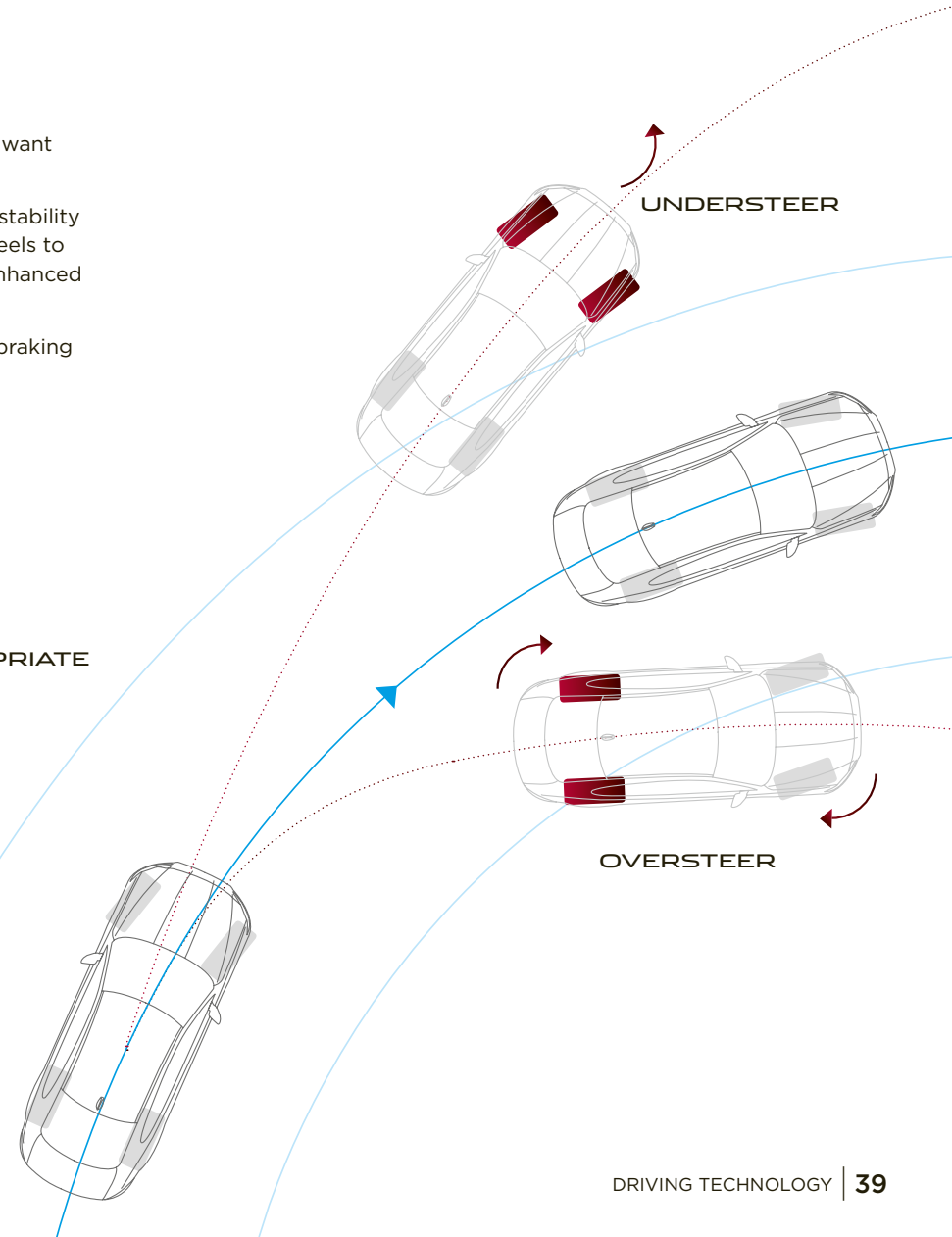



# HEAD-UP DISPLAY

## > HEAD-UP DISPLAY WITH LASER TECHNOLOGY

The optional Head-Up Display (HUD) with laser technology projects key information onto the windscreen. Remaining clear even in direct sunlight, the crisp, bright image can display vehicle speed, navigation, cruise control notifications and Traffic Sign Recognition data, where available. This technology helps you minimise time spent looking down at the instrument cluster and can help you maintain continuous awareness of the car's speed.

### ADAPTIVE CRUISE CONTROL WITH QUEUE ASSIST

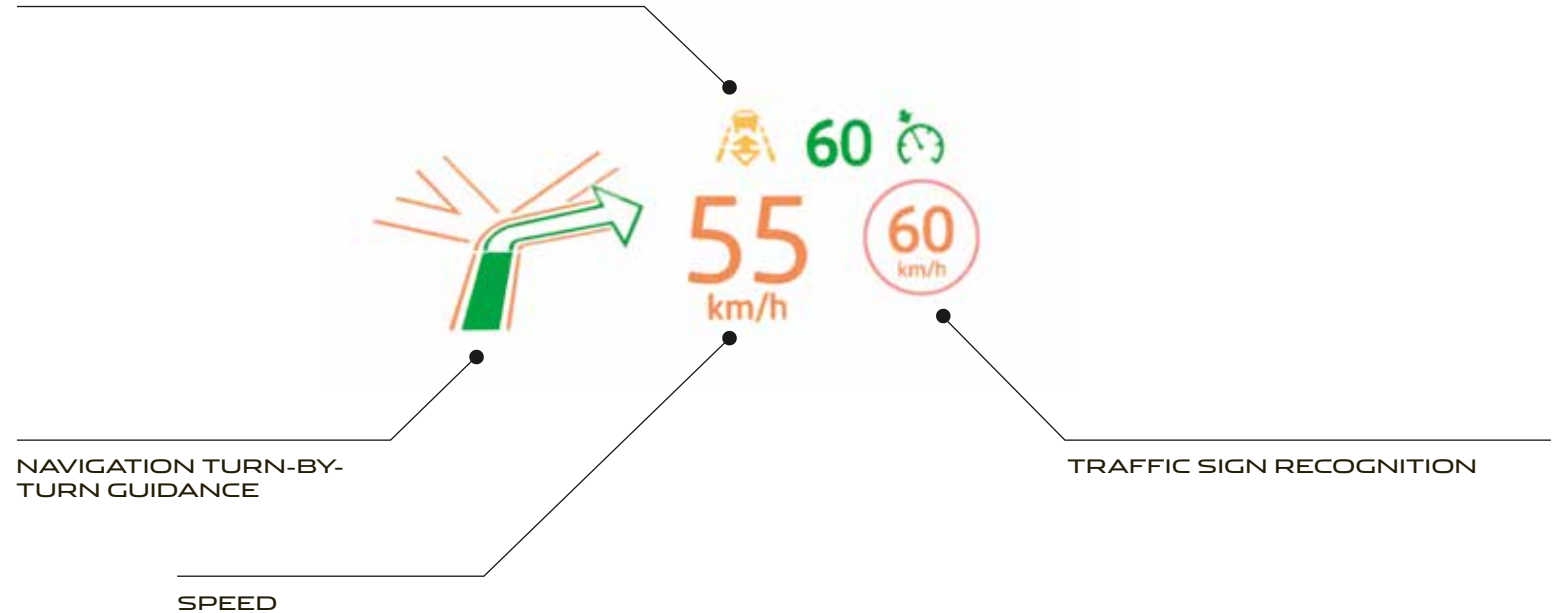



## INFOTAINMENT INCONTROL TECHNOLOGIES



INCONTROL TOUCH

INCONTROL TOUCH PRO

InControl is our suite of advanced technologies that links both you and your XF to the wider world. Choose from two InControl infotainment systems: InControl Touch, available as standard, or upgrade to InControl Touch Pro\*. These can be further enhanced by adding their respective connectivity packages, InControl Connect\* and InControl Connect Pro\*.

\*As we systematically introduce InControl, specific features, options and its availability remain market dependent.

\*\*Only available with InControl Apps or InControl Connect Pro (see optional connectivity packages for InControl Touch Pro).

Third Party programmes or applications may require an end user licence from the supplier.



### INCONTROL TOUCH



#### STANDARD ON EVERY XF

8 inch Touch-screen  
 5 inch instrument panel display with analogue dials  
 Jaguar Sound System (80W)  
 FM Radio  
 iPod, USB, Bluetooth® and AUX connections



**InControl Protect** consists of  
 SOS Emergency Call, Jaguar Optimised Assistance  
 and Remote Essentials smartphone app



#### OPTIONAL

**InControl Connect** consists of InControl Apps,  
 Remote Premium smartphone app and Wi-Fi Hotspot



**InControl Secure** provides Stolen vehicle monitoring and  
 notifications via your smartphone and the secure call centre

#### ADDITIONAL OPTIONS

Meridian Sound System (380W)  
 InControl Touch SD Navigation  
 DAB Radio

 For information on InControl Touch see pages 44-45.



### INCONTROL TOUCH PRO



#### AVAILABLE AS AN UPGRADE

10.2 inch Touch-screen with multi-touch gestures  
 and customisable homescreen  
 12.3 inch instrument panel display with virtual dials  
 and full screen 3D Map View  
 InControl Touch Pro Solid State Drive (SSD) Enhanced Navigation  
 Meridian Digital Sound System (380W)  
 FM Radio, iPod, Bluetooth® and 2 x USB connections  
 10GB of usable memory  
 CD/DVD Drive



**InControl Protect** consists of  
 SOS Emergency Call, Jaguar Optimised Assistance  
 and Remote Essentials smartphone app



#### OPTIONAL

**InControl Connect Pro** consists of InControl Apps, Remote  
 Premium smartphone app, Wi-Fi Hotspot and Pro Services



**InControl Secure** provides Stolen vehicle monitoring and  
 notifications via your smartphone and the secure call centre

#### ADDITIONAL OPTIONS

Meridian Digital Surround Sound System (825W)  
 Digital TV, HDMI\*\*, MHL\*\*  
 DAB Radio

 For information on InControl Touch Pro see pages 46-47.



8 INCH TOUCH-SCREEN SHOWN AT ACTUAL SIZE

<b>Audio</b>	Standard: Jaguar Sound System (80W) Optional: Meridian Sound System (380W)
<b>Navigation Guidance</b>	InControl Touch SD Navigation*
<b>Display</b>	5 inch instrument panel display with analogue dials
<b>Multimedia</b>	FM and DAB Radio*. iPod, USB, Bluetooth® and AUX connections
<b>Standard InControl Package</b>	InControl Protect consists of SOS Emergency Call, Jaguar Optimised Assistance and Remote Essentials smartphone app
<b>Optional Connectivity Package</b>	InControl Connect consists of InControl Apps, Remote Premium smartphone app and Wi-Fi Hotspot

\*Optional features.



# INCONTROL TOUCH



## ADVANCED INFOTAINMENT AS STANDARD

The InControl Touch multimedia system is XF's hub for connectivity, control and entertainment. The key features are:

**8 inch Touch-screen** at the heart of the centre console. Clear and responsive graphical interface for quick control.

**Easy to use Touch-screen** responds directly to touch and swipe gestures.

**Navigation guidance** makes planning journeys and following routes easy, thanks to turn-by-turn voice guidance, junction view and 3D maps. 'Dead-reckoning' functionality can accurately position the vehicle even when GPS signals can no longer be received – perfect for city centres or driving through tunnels.

**Bluetooth phone connectivity** allows you to link and control your smartphone via InControl Touch either for phone calls or music playback: simple, easy and wire-free.

**Access a world of music** thanks to FM, DAB, Satellite and HD radio (subject to regional fitment), as well as iPod, USB and AUX connections.

**Integrated text-to-voice** technology reduces distraction by reading out incoming text messages. You can easily respond with short, prepared messages.

**Precise climate control** is available via the Touch-screen. Adjust temperature levels, direction and intensity of airflow and operate heated or cooled seats (if fitted).

# INCONTROL CONNECT



## OPTIONAL CONNECTIVITY PACKAGE

InControl Connect is a bundle of technologies and applications that takes your XF's connectivity to the next level.

**InControl Apps** features a range of bespoke Jaguar approved apps that can be connected to the car from your smartphone. It ensures the safe and convenient use of these apps that have been optimised specifically to enhance aspects of your in-car experience.

**Wi-Fi Hotspot** gives you the option to create a 3G hotspot using the car's antenna when you fit a SIM card. This strengthens your link to the outside world, for a more stable connection than an individual device could maintain. Connect up to eight devices to read emails, browse the web and download content.

**Remote Premium** is a multi-function app that allows you to monitor as well as interact with your XF from your smartphone. Remote start the engine to pre-condition the climate, lock and unlock the car, locate your XF on a map or by using the beep and flash function, and track your journeys – all via the app.



Explore InControl at [jaguar.com/incontrol](http://jaguar.com/incontrol)

As we systematically introduce InControl, specific features, options and its availability remain market dependent. Please consult your local Jaguar retailer for further details. Wi-Fi Hotspot requires the fitment of a Standard SIM with a suitable data contract.



10.2 INCH TOUCH-SCREEN SHOWN AT ACTUAL SIZE

<b>Audio</b>	Standard: Meridian Digital Sound System (380W) Optional: Meridian Digital Surround Sound System (825W)
<b>Navigation Guidance</b>	InControl Touch Pro SSD Enhanced Navigation
<b>Display</b>	12.3 inch instrument panel display with virtual dials and full screen 3D Map View
<b>Multimedia</b>	FM and DAB Radio*, iPod, Bluetooth®, HDMI†, MHL† and 2 x USB connections, Digital TV*, 10GB of usable memory and CD/DVD Drive
<b>Standard InControl Package</b>	InControl Protect consists of SOS Emergency Call, Breakdown Call and Remote Essentials
<b>Optional Connectivity Packages</b>	InControl Connect Pro consists of InControl Apps, Remote Premium, Wi-Fi Hotspot and Pro Services (including Route Planner Companion App, share your destination and ETA, Commute Mode, Arrival Mode, real time traffic information and fuel and parking services)

\*Optional features.

†Only available with InControl Apps or InControl Connect Pro (see optional connectivity packages for InControl Touch Pro). Please consult your local Jaguar retailer for further details. Certain features require the fitment of a SIM with a suitable data contract.



12.3 inch Virtual Instrument Display with four graphical themes

# INCONTROL TOUCH PRO

## UPGRADE TO NEXT GENERATION INFOTAINMENT

InControl Touch Pro's next-generation hardware and software advances XF's connectivity and entertainment to the very highest level. InControl Touch Pro's features replace or enhance those found in InControl Touch. The key aspects of InControl Touch Pro are:

**Larger, highly-responsive, 10.2 inch Touch-screen** at the heart of the centre console with customisable home screen and lightning fast response times. Its interactive side panel makes multi-tasking easy.

**Pinpoint touch control** allows you to manipulate and interact with information swiftly and seamlessly. The Touch-screen responds in the same manner as a smartphone or tablet computer, providing multi-touch gestures such as pinch to zoom and swipe.

**12.3 inch Instrument Panel Display with Virtual Dials** and full screen 3D Map View makes driving even more of a pleasure. It is housed in the instrument display directly in front of the driver. Select full screen 3D Map View or choose one of four graphical themes to suit your personal preference.

**Enhanced Navigation** with response times that are a fraction of conventional systems'. One of the many innovative features of InControl Touch Pro's Navigation is that it allows you to set a destination and the system alerts you if you have insufficient fuel for the journey. It then displays filling stations on the part of the route where you may be low on fuel. The system automatically displays parking options.

**Personal media storage** of 10GB of usable memory for your music and movies. 'Plug and play' using the two USB ports allowing for fast transfer speeds.



Explore InControl at [jaguar.com/incontrol](http://jaguar.com/incontrol)

As we systematically introduce InControl, specific features, options and its availability remain market dependent. Please consult your local Jaguar retailer for further details. Certain InControl Connect Pro features require the fitment of a Micro SIM with a suitable data contract.

# INCONTROL CONNECT PRO

## OPTIONAL ENHANCED CONNECTIVITY PACKAGE

InControl Connect Pro's services, technologies and applications give you the very best in connectivity and convenience. It offers all the benefits of InControl Connect (see page 45) plus many more features, including:

**Route Planner Companion App** offers true door-to-door navigation. Pre-plan your destination and route via your Apple or Android smartphone. The app will guide you to your car, where you will find your selected route available on the car's Touch-screen. When you've completed your road journey, the app can guide you by foot or public transport (where supported) to your destination.

**Share your estimated time of arrival** so your selected contact(s) will know exactly when you will arrive, as calculated by the navigation guidance system. If you're running late, the system can then send automatic updates via text or email, without any further action from you.

**Commute Mode** allows the system to learn your commutes and automatically advises you of the expected journey time based on live and historical traffic movements. The system learns the routes you take for a given destination and then advises which of those is the quickest.

**Arrival Mode** displays interactive 360 degree street level imagery of your destination for seamless finishes to journeys. It automatically displays again upon your arrival. You then simply tap the Touch-screen to select a nearby car park, which appears as an updated destination.



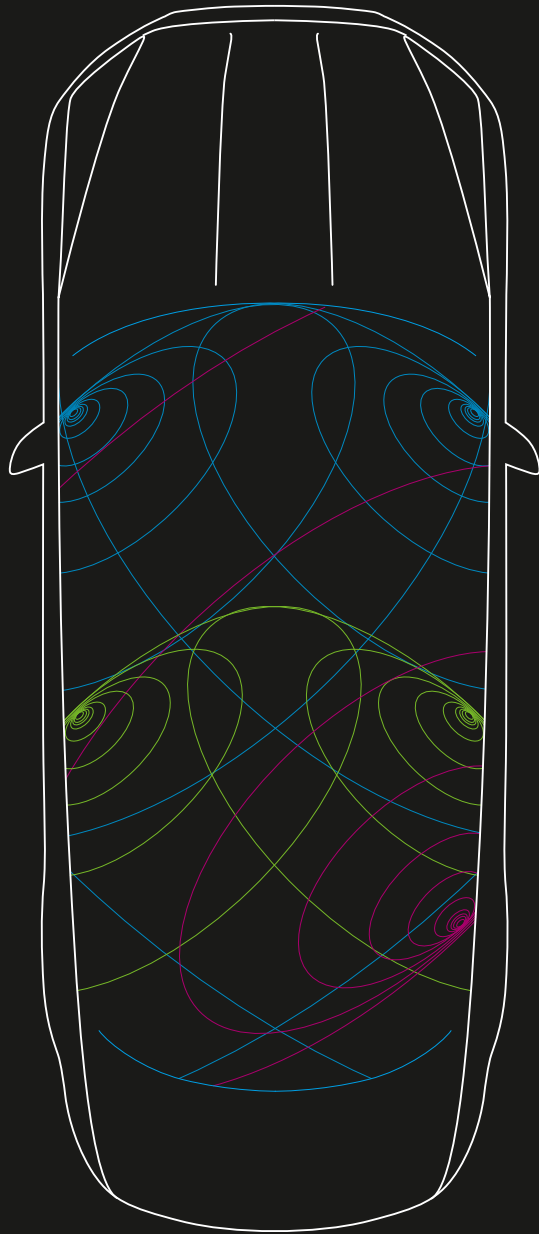

## AUDIO

 JAGUAR  
SOUND SYSTEM

MERIDIAN  
SOUND SYSTEMS

XF's superb sound systems bring your music to life. The Jaguar Sound System provides acoustic range through 8 speakers. Offering an enhanced listening experience are the optional Meridian Sound Systems. Designed in conjunction with the British audio experts Meridian, these systems use innovative audio technology and precise speaker placement to give perfectly optimised sound quality.

Choose from a range of sound systems, including the new digital 380W Sound System with 11 speakers or the digital 825W Surround Sound System with 17 speakers. All ensure that, wherever you or your passengers sit in your XF, everyone will enjoy a rich, enveloping audio experience.



-  Fresh air subwoofer
-  Front door waves tweeter midrange bass
-  Rear door waves tweeter midrange

Diagram representative of Meridian 380W Sound System.



MERIDIAN

SOUND SYSTEMS AVAILABLE IN CONJUNCTION WITH **INCONTROL TOUCH**

**Standard**

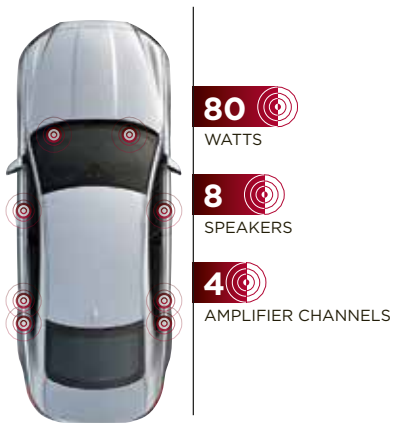

**JAGUAR SOUND SYSTEM**

Dynamic Volume Control  
80 watts; 8 speakers;  
4 amplifier channels

**Optional**

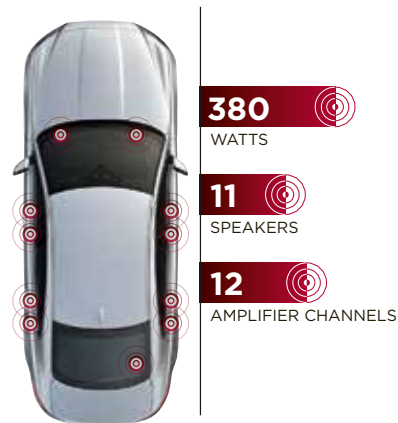

**MERIDIAN SOUND SYSTEM**

DSP amplifier,  
Dynamic Volume Control  
380 watts; 11 speakers;  
12 amplifier channels

SOUND SYSTEMS AVAILABLE IN CONJUNCTION WITH **INCONTROL TOUCH PRO**

**Standard**

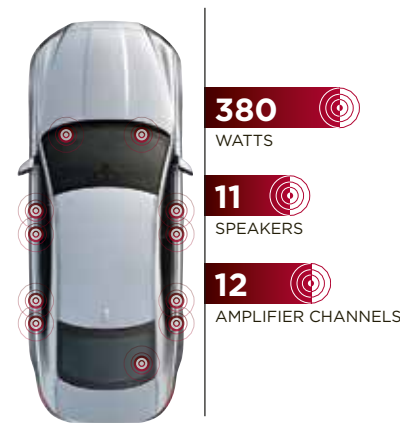

**MERIDIAN DIGITAL SOUND SYSTEM**

DSP amplifier, Audyssey MultEQ  
Audio Equalisation,  
Dynamic Volume Control  
380 watts; 11 speakers;  
12 amplifier channels

**Optional**

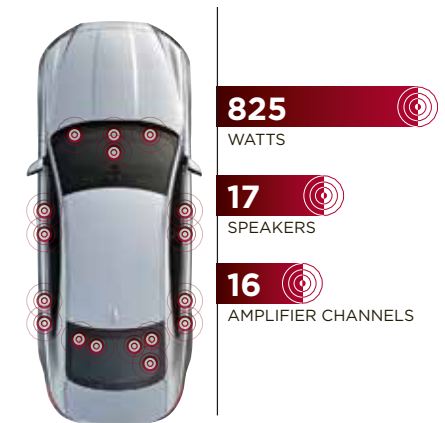

**MERIDIAN DIGITAL SURROUND SOUND SYSTEM**

DSP amplifier, Audyssey MultEQ  
Audio Equalisation,  
Dynamic Volume Control  
825 watts; 17 speakers;  
16 amplifier channels

# SAFETY AND EFFICIENCY ADVANCED DRIVER ASSISTANCE



## 1 AUTONOMOUS EMERGENCY BRAKING\*

Should a potential collision be detected XF gives an audible forward collision warning. Visual warnings follow. If the driver takes no action the system applies the brakes to help reduce the severity of the possible impact.

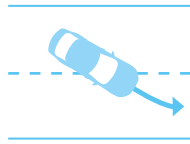

## 2 LANE DEPARTURE WARNING\*\*

Lane Departure Warning notifies the driver with a visual alert and a gentle vibration of the steering wheel should the car detect an unintentional drift from its lane, helping to keep everyone on board safe.



## 3 LANE KEEP ASSIST AND DRIVER CONDITION MONITOR\*\*

Building on Lane Departure Warning, Lane Keep Assist (LKA) senses unintentional lane drift and helps steer XF back into its lane. Driver Condition Monitor (DCM) detects lapses in concentration due to tiredness by monitoring driver inputs and suggests taking a break via an audible alert and a visual notification in the instrument cluster.



## 4 TRAFFIC SIGN RECOGNITION WITH ADAPTIVE SPEED LIMITER\*\*

Traffic Sign Recognition (TSR) technology detects speed limits, including variable limits, and no overtaking signs via the forward-facing camera, then displays them to the driver. The Adaptive Speed Limiter uses TSR's information, supported by map data from the optional navigation system, to help keep XF within the appropriate speed limit.



## 5 BLIND SPOT MONITOR AND REVERSE TRAFFIC DETECTION\*\*

Blind Spot Monitor alerts you to vehicles or obstacles beside XF, as well as ones approaching from a distance behind, via an icon displayed in the appropriate exterior mirror. Reverse Traffic Detection extends the Blind Spot Monitor function and alerts you via the Touch-screen of moving vehicles during reversing - for example, when leaving a parking bay with restricted vision.

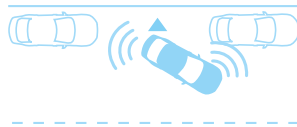

## 6 PARK ASSIST\*\*

Park Assist makes parking in tight spaces easier than ever. XF can accurately steer itself during both parallel and bay parking manoeuvres - the driver only has to control the brakes and accelerator. An exit-assist function can help guide XF while leaving a parallel space.

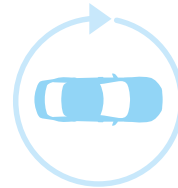

## 7 SURROUND CAMERA SYSTEM\*\*

Surround Camera System gives you 360° exterior vision on the Touch-screen. This helps with various manoeuvres from parking by a kerb to getting in and out of tight spaces and junctions.

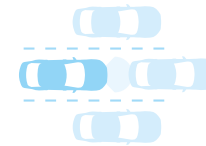

## 8 ADAPTIVE CRUISE CONTROL WITH QUEUE ASSIST\*\*

Adaptive Cruise Control† uses radar technology to automatically adjust your speed to maintain a safe distance from the vehicle ahead. If that vehicle slows, your XF reduces its speed to maintain a safe distance. XF resumes its pre-set speed as soon as the road in front is clear. Should the car in front stop completely, the Queue Assist function brings XF to a smooth halt. Once the traffic moves off, touch the accelerator and XF will follow the car in front again.

\*Standard feature.

\*\*Optional features, availability is market dependent.

†Only available with automatic transmission.



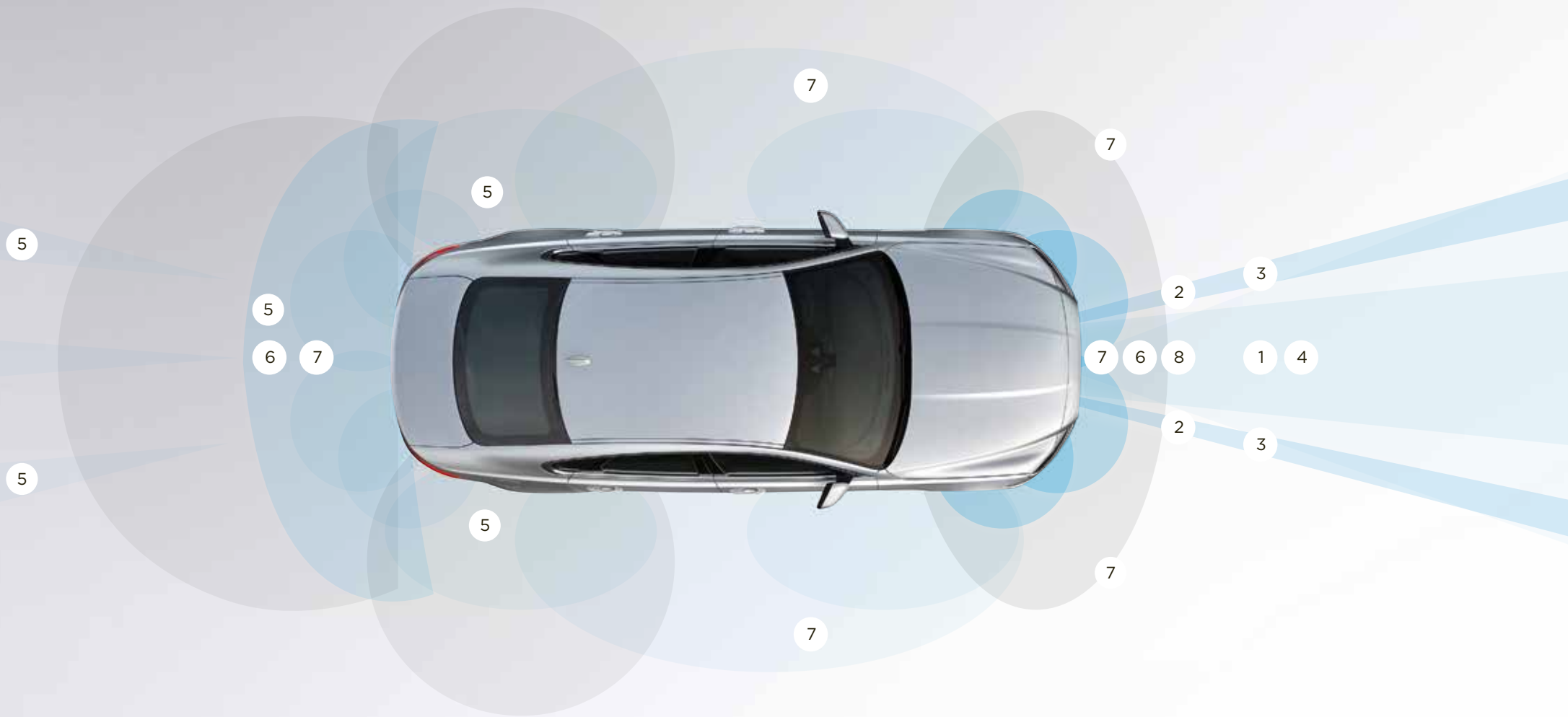

VEHICLE SHOWN: XF PRESTIGE IN RHODIUM SILVER

## EFFICIENT TECHNOLOGIES



LOW FRICTION

CLEAN TECHNOLOGIES

Everyone wants to do more with less. That is why XF uses a range of technologies to reduce fuel consumption and CO<sub>2</sub> emissions, all while staying true to Jaguar's dynamic nature.



### E-PERFORMANCE

The 2.0 litre i4 turbocharged diesel (163PS), makes use of Jaguar's highly refined and efficient Ingenium powertrain and has aerodynamic additions to the front and underbody areas. It also uses Ultra Low Rolling Resistance tyres to reduce drag between road and tyre as well as lightweight and aerodynamic alloy wheels designed for optimised efficiency. This allows XF to reduce CO<sub>2</sub> emissions to as low as 104g/km.



### STOP/START

All XF's engines are available with Stop/Start\*\*. It shuts down the engine when you come to a complete halt and restarts the engine immediately when required. XF's new system reduces battery weight by 10kg to help save fuel, especially during urban driving.

\*Available on all E-Performance models and selected 180PS and 240PS trim levels. This is market dependent.

\*\*This is market dependent.



#### 17" ALLOY WHEELS\*

XF is available with both a lightweight and aerodynamic wheel, with Ultra Low Rolling Resistance tyres to maximise efficiency without loss of Jaguar's legendary comfort.



#### ADVANCED AERODYNAMICS

XF can offer an incredibly low drag coefficient of Cd. 0.26, matching the best of its rivals. This helps XF cut through the air with ease, meaning less work for the engine and therefore reduced fuel consumption and emissions.

## AdBlue®

#### ADBLUE®\*\*

XF's diesel models are now fitted with AdBlue® to help clean exhaust gases. AdBlue® is a non-toxic, non-flammable, biodegradable additive that cleanses the gases in the car's exhaust system to remove harmful nitrogen oxide emissions.



#### LOW FRICTION TECHNOLOGIES

Technologies such as smart coatings on XF's pistons and needle roller bearings in the Ingenium range help to reduce friction, particularly at low engine temperatures. This helps the car perform at its efficient best.



# PERSONALISATION XF - YOUR CHOICE

 Configure your vehicle at [jaguar.com](http://jaguar.com)



## CHOOSE YOUR ENGINE

**Page 56**

Select one of XF's powerful, efficient petrol or diesel engines to suit your driving style.

## CHOOSE YOUR MODEL & OPTIONS

**Page 58**

Compare the wealth of standard features and options on XF models.

## CHOOSE YOUR COLOUR

**Page 66**

Express your individuality with one of XF's stunning exterior colours.



CHOOSE YOUR  
**WHEELS**

**Page 68**

Add the personal finishing touch to your new XF, and complement its stunning style, with a set of beautifully designed alloy wheels.



CHOOSE YOUR  
**INTERIOR**

**Page 70**

There's a wide selection of premium materials, leathers, veneers and finishes for every personal taste.



CHOOSE YOUR  
**JAGUAR  
ACCESSORIES**

**Page 88**

Really make it yours by adding style, practicality and versatility with official XF Accessories from your local Jaguar retailer.

# 1 CHOOSE YOUR ENGINE

 Configure your vehicle at [jaguar.com](http://jaguar.com)

## > DIESEL ENGINES

### 2.0 LITRE i4

TURBOCHARGED E-PERFORMANCE

MAXIMUM POWER 163PS
MAXIMUM TORQUE 380Nm
ACCELERATION 0-100 km/h 8.7 seconds
TOP SPEED Manual 229 km/h / Automatic 227 km/h
COMBINED Manual 4.0 l/100km Automatic 4.1 l/100km
CARBON DIOXIDE EMISSIONS Manual 104 g/km Automatic 109 g/km
PURE, PRESTIGE, PORTFOLIO, R-SPORT

### 2.0 LITRE i4

TURBOCHARGED

MAXIMUM POWER 180PS
MAXIMUM TORQUE 430Nm
ACCELERATION 0-100 km/h Manual 8.0 seconds / Automatic 8.1 seconds
TOP SPEED Manual 230 km/h / Automatic 229 km/h
COMBINED 4.3 l/100km
CARBON DIOXIDE EMISSIONS 114 g/km
PURE, PRESTIGE, PORTFOLIO, R-SPORT

### 3.0 LITRE V6

TWIN TURBOCHARGED

MAXIMUM POWER 300PS
MAXIMUM TORQUE 700Nm
ACCELERATION 0-100 km/h 6.2 seconds
TOP SPEED 250 km/h
COMBINED 5.5 l/100km
CARBON DIOXIDE EMISSIONS 144 g/km
PRESTIGE, PORTFOLIO, R-SPORT

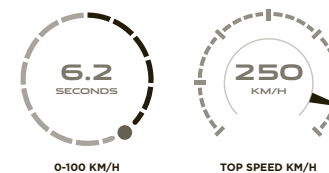
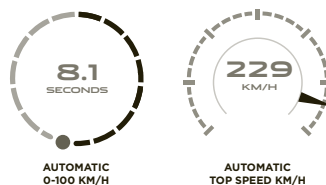
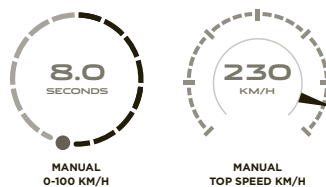
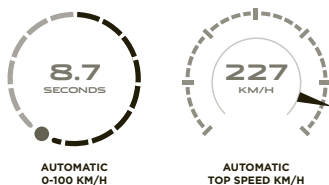
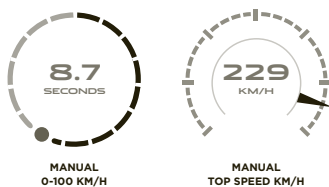

Please refer to Technical Specification pages for full fuel consumption figures.  
The figures provided are as a result of official manufacturer's tests in accordance with EU legislation.  
A vehicle's actual fuel consumption may differ from that achieved in such tests and these figures are for comparative purposes only.



## > PETROL ENGINES

### 2.0 LITRE i4

TURBOCHARGED

MAXIMUM POWER 240PS

MAXIMUM TORQUE 340Nm

ACCELERATION 0-100 km/h 7.0 seconds

TOP SPEED 248 km/h

COMBINED 7.5 l/100km

CARBON DIOXIDE EMISSIONS 179 g/km

PURE, PRESTIGE, PORTFOLIO, R-SPORT

### 3.0 LITRE V6

SUPERCHARGED

MAXIMUM POWER 340PS

MAXIMUM TORQUE 450Nm

ACCELERATION 0-100 km/h 5.4 seconds

TOP SPEED 250 km/h

COMBINED RWD 8.3 l/100km AWD 8.6 l/100km

CARBON DIOXIDE EMISSIONS

RWD 198 g/km AWD 204 g/km

PURE, PRESTIGE, PORTFOLIO, R-SPORT

### 3.0 LITRE V6

SUPERCHARGED

MAXIMUM POWER 380PS

MAXIMUM TORQUE 450Nm

ACCELERATION 0-100 km/h 5.3 seconds

TOP SPEED 250 km/h

COMBINED RWD 8.3 l/100km AWD 8.6 l/100km

CARBON DIOXIDE EMISSIONS

RWD 198 g/km AWD 204 g/km

S



0-100 KM/H



TOP SPEED KM/H



0-100 KM/H

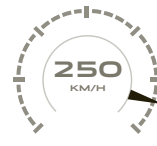

TOP SPEED KM/H



0-100 KM/H

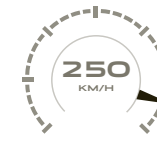

TOP SPEED KM/H

# 2 CHOOSE YOUR MODEL

 Configure your vehicle at [jaguar.com](http://jaguar.com)

## > LUXURY



### PURE

#### KEY FEATURES

- 17" alloy wheels (18" alloy wheels on V6 engines)
- Halogen headlights
- Premium cloth seats
- 10-way electric front seats\*
- Gloss Black veneer
- Morse Code Aluminium instrument panel finisher
- All Surface Progress Control (Automatic Transmission only)



### PRESTIGE

#### KEY FEATURES (IN ADDITION TO PURE)

- Bi-function Xenon headlights with LED J-Blade and powerwash
- Taurus leather seats
- Rear armrest with cupholders
- Soft grain leather steering wheel
- Carpet mats
- Interior Mood Lighting



### PORTFOLIO

#### KEY FEATURES (IN ADDITION TO PRESTIGE)

- 18" alloy wheels (17" alloy wheels on 163PS Diesel engine)
- Windsor leather seats
- Windsor leather instrument panel finisher
- Gloss Figured Ebony veneer

\*8-way manual front seats with electric recline standard on XF Pure 163PS Diesel engine.  
Images feature optional equipment.  
Please note that standard features may be replaced when selecting alternative trim levels.  
Standard features may also vary depending on country of purchase, engine variant and transmission,  
please refer to Specification and Price Guide or website for your local market.

## > SPORT



### R-SPORT

#### KEY FEATURES (IN ADDITION TO PRESTIGE)

- 18" alloy wheels (17" alloy wheels on 163PS Diesel engine)
- 'R-Sport' body kit including sports front bumper, side sills and boot mounted spoiler
- Sports suspension (180PS Diesel and 240PS Petrol only)
- Sports Taurus leather seats with technical mesh inserts
- Metal tread plates and multi-function steering wheel with 'R-Sport' branding
- Gloss Black side window surround
- Dark Morse Code Aluminium instrument panel finisher



### S

#### KEY FEATURES (IN ADDITION TO R-SPORT)

- 19" alloy wheels
- 'S' body kit including sports front bumper, Gloss Black side sills, rear valance and boot mounted spoiler
- Red Brake Calipers
- Sports Taurus leather 'S' embossed seats with suedecloth inserts
- Grey Figured Ebony veneer
- Dark Hex Aluminium instrument panel finisher
- Bright sport pedals
- Metal tread plates and multi-function steering wheel with 'S' branding
- Adaptive Dynamics

# 2 CHOOSE YOUR OPTIONS

 Configure your vehicle at [jaguar.com](http://jaguar.com)

## KEY STANDARD FEATURES

	PURE	PRESTIGE	PORTFOLIO	R-SPORT	S	DESCRIPTION
Intelligent Stop/Start system	●	●	●	●	●	Refer to page 52
Hill Launch Assist	●	●	●	●	●	Prevents your XF from rolling backwards when pulling away on an incline, helping you to make the perfect hill start every time
JaguarDrive Control with Eco, Dynamic, Normal and Winter mode	●	●	●	●	●	Refer to page 22
Electric Power Assisted Steering (EPAS)	●	●	●	●	●	Refer to page 31
Electric Parking Brake with drive away release	●	●	●	●	●	Automatically releases the parking brake without the need for driver input as you press the accelerator to drive away
Emergency Brake Assist	●	●	●	●	●	Increases braking pressure in an emergency situation
Autonomous Emergency Braking	●	●	●	●	●	Refer to page 50
Hazard lights under heavy braking	●	●	●	●	●	
Airbags	●	●	●	●	●	Driver and front passenger with seat occupant detector for passenger, front side and full length side window curtain
Torque Vectoring	●	●	●	●	●	Refer to page 36
Dynamic Stability Control and Traction Control	●	●	●	●	●	Refer to page 39
Cruise Control with Speed Limiter	●	●	●	●	●	
Lane Departure Warning	●	●	●	●	●	Refer to page 50
Trailer Stability Control	●	●	●	●	●	Intervenes when the system detects sway or potentially dangerous movement to bring the trailer back under control
Electric front and rear windows with one-touch open/close and anti-trap	●	●	●	●	●	
Rain sensing windscreen wipers	●	●	●	●	●	
Body coloured, heated, electric exterior door mirror	●	●	●	●	●	
Two-zone climate control	●	●	●	●	●	
USB, Auxiliary socket and iPod® connectivity	●	●	●	●	●	Refer to page 43
Bluetooth® telephone connectivity	●	●	●	●	●	Refer to page 43
Bluetooth® streaming	●	●	●	●	●	Refer to page 43
Interior lighting	●	●	●	●	●	
Jaguar Smart Key System – Keyless Start	●	●	●	●	●	

\*Not available on 163PS Diesel or V6 engines

\*\*Not available on 163PS Diesel

● Standard ○ Option — Not available

Please consult your local Jaguar retailer for details.

For a complete list of optional features and packs refer to the XF Specification and Price Guide or configure your vehicle at [jaguar.com](http://jaguar.com)



## KEY OPTIONAL FEATURES

		PURE	PRESTIGE	PORTFOLIO	R-SPORT	S	
DYNAMIC FEATURES		CODE					DESCRIPTION
Six-speed manual transmission with Optimal Shift Indicator (only available on 2.0L i4 diesel engines)		●	●	●	●	—	Refer to page 23
Eight-speed automatic transmission with Jaguar Sequential Shift, gearshift change paddles and All Surface Progress Control		○	○	○	○	●	Refer to page 22
Sports suspension upgrade*	C31S	○	○	○	●	—	Adds Sports springs and dampers
Adaptive Dynamics** (requires automatic transmission, includes Configurable Dynamics when V6 engine with InControl Touch is selected)	C35A	—	○	○	○	●	Refer to page 29 and 31
Adaptive Cruise Control with Queue Assist (requires automatic transmission)	H41F	○	○	○	○	○	Refer to page 50
Adaptive Surface Response (replaces Winter mode, requires AWD, automatic transmission and Adaptive Dynamics)	B73F	—	○	○	○	○	Refer to page 35

## EXTERIOR FEATURES AND FINISHERS

EXTERIOR FEATURES AND TRIM							
Electric tilt/slide sunroof	F45C	○	○	○	○	○	
Powered Electrical boot lid (open and close)	B69B	○	○	○	○	○	
Soft Door Close (requires Keyless Entry)	F42D/F42C	○	○	○	○	○	Automatically ensures that doors close softly, securely and with minimum exertion
Chrome radiator grille with Chrome surround	G12V	—	○	○	—	—	
Chrome side window surround	D53C	●	●	●	○	○	
R-Sport body kit		—	—	—	●	—	Includes R-Sport front bumper, body coloured side sills and boot lid mounted spoiler, Satin Chrome side power vents with R-Sport badge
S body kit		—	—	—	—	●	Includes S front bumper, Gloss Black side sills and rear valence, body coloured boot lid mounted spoiler, Satin Chrome side power vents
Engine De-badge	B05H	○	○	○	○	—	Removes engine badging

# 2 CHOOSE YOUR OPTIONS

 Configure your vehicle at [jaguar.com](http://jaguar.com)

## EXTERIOR FEATURES AND FINISHERS CONTINUED

		PURE	PRESTIGE	PORTFOLIO	R-SPORT	S	
<b>GLASS AND EXTERIOR MIRRORS</b>							<b>DESCRIPTION</b>
Infrared Reflective windscreen (front screen only)	D97B	○	○	○	○	○	Filters sunlight to reduce glare and prevent harmful UV rays from entering the cabin
Heated front windscreen with heated washer jets	D96A	○	○	○	○	○	
Privacy Glass	H75A	○	○	○	○	○	
Power fold exterior mirrors in body colour, heated and auto-dimming with approach lamps and clear side turn indicators (requires interior auto-dimming mirror)	B28P	○	○	○	○	○	
<b>HEADLIGHTS AND LIGHTING</b>							
Halogen headlights with Daytime Running Lights		●	—	—	—	—	
Bi-function Xenon headlights with LED J-Blade Daytime Running Lights, automatic levelling and headlight powerwash	D90L	○	●	●	●	●	
LED headlights with LED J-Blade Daytime Running Lights, adaptive lighting, turning light, Automatic High Beam Assist and headlight powerwash	D90T	○	○	○	○	○	Refer to page 10
<b>TOWING</b>							
Detachable tow bar	C05C	○	○	○	○	○	
Electrically deployable tow bar	C05B	○	○	○	○	○	
<b>EXTERIOR COLOURS</b>							(Please see pages 66-67 for full colour palette)
Solid paint		●	●	●	●	●	Refer to page 66
Metallic paint		○	○	○	○	○	Refer to page 66-67
Premium paint		○	○	○	○	○	Refer to page 67
<b>WHEELS</b>							(Availability of wheels is subject to choice of engine, please see pages 68-69 to see the full range)
Jaguar Tyre Repair System		●	●	●	●	●	
Space saver spare wheel (18")	C40D	○	○	○	○	○	
Tyre Pressure Monitoring System		●	●	●	●	●	
Locking Wheel Nuts	C25A	○	○	○	○	○	

● Standard ○ Option — Not available

Please consult your local Jaguar retailer for details.

For a complete list of optional features and packs refer to the XF Specification and Price Guide or configure your vehicle at [jaguar.com](http://jaguar.com)

## SEATING AND VENEERS

		PURE	PRESTIGE	PORTFOLIO	R-SPORT	S	
SEATING	CODE						DESCRIPTION
Heated front seats	F53A	○	○	○	○	○	
Heated front and rear seats	F53B	—	○	○	○	○	
Climate front seats (requires leather seats and 4-way electric lumbar adjust)	F53F	—	○	○	○	○	Heated and cooled front seats
Climate front seats and heated rear seats (requires leather seats and 4-way electric lumbar adjust)	F53C	—	○	○	○	○	Heated and cooled front and rear seats
8-way manual front seat with electric recline (standard on 163PS engine only)		●	—	—	—	—	
10-way electric front seats with manual headrest height (optional on 163PS engine only)	Z03V	○/●	●	●	●	●	
4-way electric lumbar adjust (only available with 10-way seats)	F52A	○	○	○	○	○	
Driver Memory (only available with 10-way seats)	H44N	○	○	○	○	○	Adjusts driver seat, mirrors and steering column
14-way electric front Sports seats	Z03Q	—	—	—	—	○	With manual headrest height, 4-way electric lumbar adjust and Passenger and Driver Memory
14-way electric front Luxury seats	Z03Z	—	—	○	—	—	With manual headrest height, 4-way electric lumbar adjust and Passenger and Driver Memory
Sports Taurus leather seats	B41T	—	—	—	○	○	
40:20:40 split fold rear seat with arm rest	H48W	○	○	○	○	○	

## VENEERS

Please see pages 86-87 for full range of veneers

## HEADLINING AND INTERIOR FEATURES

HEADLINING						
Light Oyster headlining	HAMT	●	●	●	○	○
Jet headlining	HPDB	○	○	○	●	●
Suedecloth headlining	H01D	○	○	○	○	○

# 2 CHOOSE YOUR OPTIONS

 Configure your vehicle at [jaguar.com](http://jaguar.com)

## HEADLINING AND INTERIOR FEATURES CONTINUED

		PURE	PRESTIGE	PORTFOLIO	R-SPORT	S	
<b>INTERIOR FEATURES</b>		<b>CODE</b>					<b>DESCRIPTION</b>
Illuminated metal tread plates with Jaguar script	F28F	—	○	○	○	○	
Carpet mats	H69H	○	●	●	●	●	
Premium carpet mats	H69K	○	○	○	○	○	
Bright Sport pedals	G48S	○	○	○	○	●	
Heated steering wheel (requires heated front seats)	F97A	○	○	○	○	○	
Electrically adjustable steering column	D07J	○	○	○	○	○	
Auto-dimming Interior Rear View Mirror	B68B	○	○	○	○	○	
Timed climate with remote heat function	H10F	○	○	○	○	○	
Four-zone climate control with two additional power sockets (requires Air Quality Sensor and Cooled Glove Box)	C88G	○	○	○	○	○	Refer to page 98
Air Quality Sensor and Cooled Glove Box	C89A, B23H	○	○	○	○	○	
Manual rear side window sunblinds	H73B	○	○	○	○	○	
Electric rear window sunblind	H76G	○	○	○	○	○	
Interior Mood Lighting	B65A	○	●	●	●	●	
Configurable Interior Mood Lighting with ten colours	B65B	○	○	○	○	○	Refer to page 19
Smoker's Pack	A03B	○	○	○	○	○	Includes single ashtray and single cigar lighter
Two additional power sockets	D72B	○	○	○	○	○	Additional 12V power socket in rear centre console and boot
<b>SAFETY AND SECURITY</b>							
Front Parking Aid (requires Rear Parking Aid)	C13A	○	○	○	○	○	
Rear Parking Aid	C11A	○	○	○	○	○	
Rear View Camera	C14A	○	○	○	○	○	
Surround Camera System (requires power fold mirrors)	C14D	○	○	○	○	○	Refer to page 50
Park Assist (requires Front and Rear Parking Aids)	C18B	○	○	○	○	○	Parallel and Perpendicular Parking
360° Parking Aid (requires Front and Rear Parking Aids)	C17A	○	○	○	○	○	
Garage door opener (HomeLink®, requires Auto-dimming Interior Rear View Mirror)	B39N	○	○	○	○	○	
Lane Keep Assist and Driver Condition Monitor	H72D	○	○	○	○	○	Refer to page 50
Blind Spot Monitor and Reverse Traffic Detection (requires power fold mirrors and Rear Parking Aid)	H71C	○	○	○	○	○	Refer to page 50
Traffic Sign Recognition with Adaptive Speed Limiter (requires Navigation)	A41B	○	○	○	○	○	Refer to page 50
Jaguar Smart Key System – Keyless Entry	F04B	○	○	○	○	○	

\*Not available on 163PS engine

● Standard ○ Option — Not available

Please consult your local Jaguar retailer for details.

For a complete list of optional features and packs refer to the XF Specification and Price Guide or configure your vehicle at [jaguar.com](http://jaguar.com)



## INFORMATION, COMMUNICATION AND ENTERTAINMENT

		PURE	PRESTIGE	PORTFOLIO	R-SPORT	S	
<b>FEATURES ONLY AVAILABLE WITH INCONTROL TOUCH</b>							
InControl Touch with 8 inch Touch-screen		●	●	●	●	●	Refer to page 45
5 inch instrument panel display with analogue dials		●	●	●	●	●	Refer to page 45
InControl Touch SD Navigation	G61C	○	○	○	○	○	Refer to page 45
Jaguar Sound System (80W)		●	●	●	●	●	Refer to page 48-49
Meridian™ Sound System (380W)	B44V	○	○	○	○	○	Refer to page 48-49
InControl Connect	Z77F	○	○	○	○	○	InControl Connect consists of InControl Apps, Remote Premium and Wi-Fi Hotspot
<b>FEATURES ONLY AVAILABLE WITH OPTIONAL INCONTROL TOUCH PRO</b>							
InControl Touch Pro with 10.2 inch Touch-screen, 12.3 inch HD Virtual Instrument Display, SSD Navigation and Meridian™ Digital Sound System (380W)	Z59X	○	○	○	○	○	Refer to page 47-49
InControl Touch Pro with 10.2 inch Touch-screen, 12.3 inch HD Virtual Instrument Display, SSD Navigation and Meridian™ Digital Surround Sound (825W)	Z59Y	○	○	○	○	○	Refer to page 47-49
InControl Connect Pro	Z77G	○	○	○	○	○	Refer to page 47
Digital TV Tuner	G52G	○	○	○	○	○	Refer to page 43
<b>FEATURES ONLY AVAILABLE WITH INCONTROL TOUCH AND INCONTROL TOUCH PRO</b>							
InControl Protect		●	●	●	●	●	Includes SOS Emergency Call, Jaguar Optimised Assistance and Remote Essentials smartphone app. Refer to page 43
InControl Secure	D44A	○	○	○	○	○	Stolen Vehicle Tracking via your smartphone app. Refer to page 43
Head-Up Display with Infrared Reflective Windscreen	Z13A	○	○	○	○	○	Refer to page 41
DAB Radio	B51A	○	○	○	○	○	Refer to page 43
<b>OPTION PACKS</b>							
Cold Climate Pack	Z88D	○	○	○	○	○	Consists of heated front windscreen, heated washer jets, heated steering wheel and heated front and rear seats (heated front only on Pure)
Power Convenience Pack	Z28B	○	○	○	○	○	Consists of Keyless Entry, powered electrical boot lid and 2 additional power sockets
Parking Pack	Z68S	○	○	○	○	○	Consists of Front and Rear Parking Aids and rear view camera
Advanced Park Assist Pack	Z68T	○	○	○	○	○	Consists of Parking Pack features plus 360° Parking Aid and Park Assist. Refer to page 50
Advanced Park Assist Pack with Surround Camera System	Z68U	○	○	○	○	○	Consists of Advanced Parking Assist Pack features plus Surround Camera System (replaces rear view camera). Refer to page 50
Active Safety Pack	Z76C	○	○	○	○	○	Consists of Adaptive Cruise Control with Queue Assist (only available with automatic transmission), Lane Keep Assist and Driver Condition Monitor, Blind Spot Monitor and Reverse Traffic Detection (requires power fold mirrors and Rear Parking Aid)
Black Pack	Z93L	—	○	○	○	○	Consists of Gloss Black radiator grille and surround, side power vents, boot lid finisher, side window surround and body kit blades (except S)
Rear Comfort Pack*	Z12A	○	○	○	○	○	Consists of heated front and rear seats (heated front seats only on Pure), four-zone climate control, manual rear side window sunblinds and electric rear window sunblind (requires Air Quality Sensor and Cooled Glove Box)

# 3 CHOOSE YOUR COLOUR

 [Configure your vehicle at jaguar.com](https://www.jaguar.com)

## SOLID

Polaris White

Ebony Black

## METALLIC

Glacier White

Ultimate Black

Rhodium Silver

Ammonite Grey

Dark Sapphire Blue

British Racing Green

Italian Racing Red



PREMIUM PALETTE

Quartzite

Odyssey Red

Aurora Red

Storm Grey

Black Berry

Tempest Grey

Celestial Black

Ingot

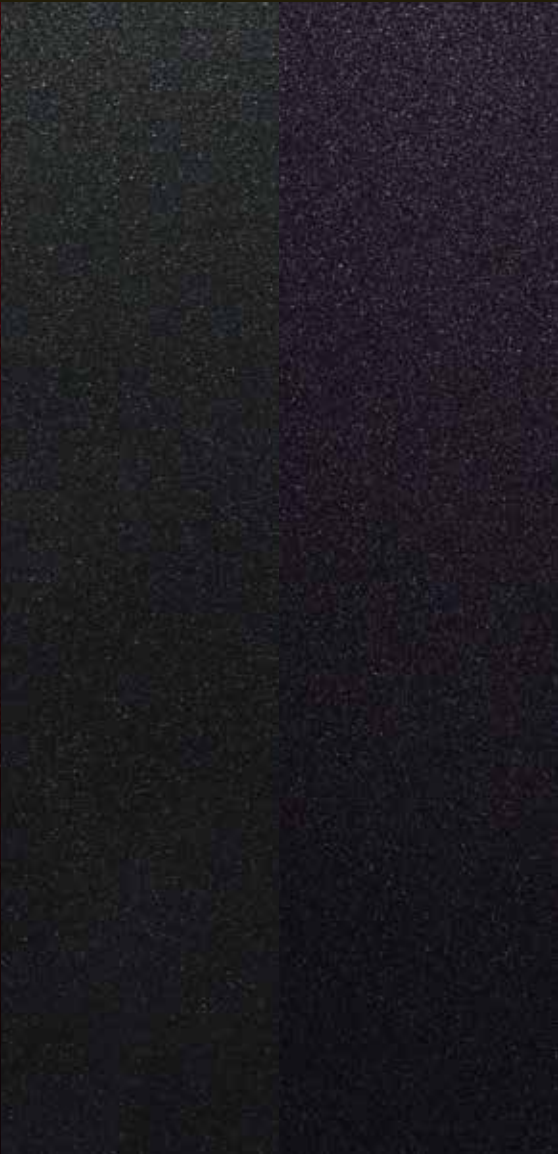

# 4 CHOOSE YOUR WHEELS

 Configure your vehicle at [jaguar.com](http://jaguar.com)



17" AERODYNAMIC 10 SPOKE<sup>1</sup>



17" LIGHTWEIGHT 15 SPOKE<sup>2</sup>



17" TURBINE 9 SPOKE<sup>2</sup>



18" FAN 5 SPOKE\*



18" CHALICE 7 TWIN SPOKE\*

ALLOY WHEEL FINISH	Sparkle Silver	Sparkle Silver	Sparkle Silver	Sparkle Silver	Sparkle Silver
ALLOY WHEEL/SIZE	7.5J x 17"	7.5J x 17"	7.5J x 17"	8.0J x 18"	8.0J x 18"
TYRE SIZE	225/55 R17	225/55 R17	225/55 R17	245/45 R18	245/45 R18
CODE	C54A	C54B	C54C	C53R	C53S
Pure	—	●	○*	○/● <sup>3</sup>	○
Prestige	○	●	○ <sup>2</sup>	○/● <sup>3</sup>	○
Portfolio	●	○ <sup>1</sup>	○ <sup>1</sup>	○	●
R-Sport	○	○ <sup>1</sup>	● <sup>1</sup>	○	○
S	—	—	—	—	—



18" HELIX 10 SPOKE\*



18" HELIX 10 SPOKE\*



18" HELIX 10 SPOKE\*



19" RAZOR 7 TWIN SPOKE\*



19" AXIS 14 SPOKE\*

ALLOY WHEEL FINISH	Sparkle Silver	Contrast/Diamond Turned	Gloss Black	Sparkle Silver	Sparkle Silver
ALLOY WHEEL/SIZE	8.0J x 18"	8.0J x 18"	8.0J x 18"	8.0J x 19"	8.0J x 19"
TYRE SIZE	245/45 R18	245/45 R18	245/45 R18	245/40 R19	245/40 R19
CODE	C53T	C53P	C530	C53U	C53V
Pure	○	○	○	○	○
Prestige	○	○	○	○	○
Portfolio	○	○	○	○	○
R-Sport	●	○	○	○	○
S	—	—	—	○	○

● Standard ○ Option — Not Applicable \*Not available with 163PS Diesel engine

<sup>1</sup>Only available on models with 163PS Diesel engine <sup>2</sup>Only available on i4 engines <sup>3</sup>Optional on i4 engines, standard on V6 engines

Standard and optional features may differ depending on market availability.





19" AXIS  
14 SPOKE\*



19" VORTEX  
10 SPOKE\*



19" BLADE  
5 SPOKE\*



19" BLADE  
5 SPOKE\*



20" MATRIX  
9 TWIN SPOKE\*

ALLOY WHEEL FINISH	Contrast/Diamond Turned	Sparkle Silver	Gloss Grey/Diamond Turned	Gloss Black	Sparkle Silver
ALLOY WHEEL/SIZE	8.0J x 19"	8.0J x 19"	8.0J x 19"	8.0J x 19"	8.5J x 20"
TYRE SIZE	245/40 R19	245/40 R19	245/40 R19	245/40 R19	255/35 R20
CODE	C53Z	C53W	C53Y	C53X	C53H

Pure	<input type="radio"/>	<input type="radio"/>	<input type="radio"/>	<input type="radio"/>	<input type="radio"/>
Prestige	<input type="radio"/>	<input type="radio"/>	<input type="radio"/>	<input type="radio"/>	<input type="radio"/>
Portfolio	<input type="radio"/>	<input type="radio"/>	<input type="radio"/>	<input type="radio"/>	<input type="radio"/>
R-Sport	<input type="radio"/>	<input type="radio"/>	<input type="radio"/>	<input type="radio"/>	<input type="radio"/>
S	<input type="radio"/>	<input type="radio"/>	<input checked="" type="radio"/>	<input type="radio"/>	<input type="radio"/>



20" MATRIX  
9 TWIN SPOKE\*



20" STAR  
5 TWIN SPOKE\*



20" VENOM  
5 TWIN SPOKE\*



20" VENOM  
5 TWIN SPOKE\*



20" LABYRINTH  
5 TWIN SPOKE\*

ALLOY WHEEL FINISH	Contrast/Diamond Turned	Sparkle Silver	Gloss Dark Grey/Diamond Turned	Gloss Black	Gloss Dark Grey/Diamond Turned
ALLOY WHEEL/SIZE	8.5J x 20"	8.5J x 20"	8.5J x 20"	8.5J x 20"	8.5J x 20"
TYRE SIZE	255/35 R20	255/35 R20	255/35 R20	255/35 R20	255/35 R20
CODE	C53J	C53K	C53F	C53L	C53G

Pure	<input type="radio"/>	<input type="radio"/>	<input type="radio"/>	<input type="radio"/>	<input type="radio"/>
Prestige	<input type="radio"/>	<input type="radio"/>	<input type="radio"/>	<input type="radio"/>	<input type="radio"/>
Portfolio	<input type="radio"/>	<input type="radio"/>	<input type="radio"/>	<input type="radio"/>	<input type="radio"/>
R-Sport	<input type="radio"/>	<input type="radio"/>	<input type="radio"/>	<input type="radio"/>	<input type="radio"/>
S	<input type="radio"/>	<input type="radio"/>	<input type="radio"/>	<input type="radio"/>	<input type="radio"/>

# 5 CHOOSE YOUR INTERIOR

 Configure your vehicle at [jaguar.com](http://jaguar.com)

PURE						
	SEAT WITH TONAL STITCH	UPPER FACIA WITH TONAL STITCH	INTERIOR TRIM AND OPTION CODES	HEADLINING MORZINE*	CARPET	VENEER
<b>Standard</b>						
Premium cloth seats (EU only)	Jet with Jet	Jet with Jet	TR23	Jet** or Light Oyster	Jet	Gloss Black
	Latte with Latte	Espresso with Espresso	TR24	Light Oyster	Espresso	Gloss Black
PRESTIGE						
	SEAT WITH TONAL STITCH	UPPER FACIA WITH TONAL STITCH	INTERIOR TRIM AND OPTION CODES	HEADLINING MORZINE*	CARPET	VENEER
<b>Standard</b>						
Taurus Leather seats	Jet with Jet	Jet with Jet	TR26	Jet** or Light Oyster	Jet	Gloss Black
	Latte with Latte	Espresso with Espresso	TR27	Light Oyster	Espresso	Gloss Black
	Light Oyster with Light Oyster	Oyster with Oyster	TR28	Light Oyster	Oyster	Gloss Black
PORTFOLIO						
	SEAT WITH TONAL STITCH	UPPER FACIA WITH TONAL STITCH	INTERIOR TRIM AND OPTION CODES	HEADLINING MORZINE*	CARPET	VENEER
<b>Standard</b>						
Windsor Leather seats	Jet with Jet	Jet with Jet	TR37	Jet** or Light Oyster	Jet	Gloss Figured Ebony
	Latte with Latte	Espresso with Espresso	TR38	Light Oyster	Espresso	Gloss Figured Ebony
	Light Oyster with Light Oyster	Oyster with Oyster	TR39	Light Oyster	Oyster	Gloss Figured Ebony
	Espresso with Espresso	Espresso with Espresso	TR40	Light Oyster	Espresso	Gloss Figured Ebony
	Siena Tan with Siena Tan	Jet with Jet	TR41	Jet** or Light Oyster	Jet	Gloss Figured Ebony

\*Suedecloth headlining available as an option.  
 \*\*Jet headlining available as an option.  
 †Light Oyster headlining available as an option.

<b>R-SPORT</b>						
	<b>DUOTONE SEAT WITH CONTRAST STITCH</b>	<b>UPPER FACIA WITH CONTRAST STITCH</b>	<b>INTERIOR TRIM AND OPTION CODES</b>	<b>HEADLINING MORZINE*</b>	<b>CARPET</b>	<b>VENEER</b>
<b>Standard</b>						
Sports Taurus Leather seats with technical mesh inserts	Jet/Jet with Light Oyster	Jet with Light Oyster	TR29	Jet or Light Oyster†	Jet	Gloss Black
<b>Optional</b>						
Taurus Leather Sports seats	Jet/Jet with Light Oyster	Jet with Light Oyster	TR29 + B41T	Jet or Light Oyster†	Jet	Gloss Black
	Jet/Red with Red	Jet with Red	TR30	Jet or Light Oyster†	Jet	Gloss Black
	Jet/Light Oyster with Light Oyster	Jet with Light Oyster	TR31	Jet or Light Oyster†	Jet	Gloss Black
	Brogue/Brogue with Light Oyster	Jet with Light Oyster	TR32	Jet or Light Oyster†	Jet	Gloss Black
<b>S</b>						
	<b>DUOTONE SEAT WITH CONTRAST STITCH</b>	<b>UPPER FACIA WITH CONTRAST STITCH</b>	<b>INTERIOR TRIM AND OPTION CODES</b>	<b>HEADLINING MORZINE*</b>	<b>CARPET</b>	<b>VENEER</b>
<b>Standard</b>						
Sports Taurus Leather seats with Suedecloth inserts	Jet/Jet with Light Oyster	Jet with Light Oyster	TR33	Jet or Light Oyster†	Jet	Grey Figured Ebony
	Red/Jet with Jet	Jet with Red	TR34	Jet or Light Oyster†	Jet	Grey Figured Ebony
<b>Optional</b>						
Taurus Leather Sports seats	Jet/Jet with Light Oyster	Jet with Light Oyster	TR33 + B41T	Jet or Light Oyster†	Jet	Grey Figured Ebony
	Red/Jet with Jet	Jet with Red	TR34 + B41T	Jet or Light Oyster†	Jet	Grey Figured Ebony
	Light Oyster/Jet with Jet	Jet with Light Oyster	TR35	Jet or Light Oyster†	Jet	Grey Figured Ebony
	Brogue/Brogue with Light Oyster	Jet with Light Oyster	TR36	Jet or Light Oyster†	Jet	Grey Figured Ebony

# 5 CHOOSE YOUR INTERIOR

⚙️ Configure your vehicle at [jaguar.com](https://www.jaguar.com)

Interior shown: Jet cloth seats with Jet facia, Morse Code Aluminium finisher, Gloss Black veneer and optional Jet headlining.











# PURE

## INTERIOR COLOUR COMBINATIONS

### STANDARD

①	②	③	④	⑤	⑥
SEAT WITH TONAL STITCH	VENEER	HEADLINING MORZINE*	UPPER FACIA WITH TONAL STITCH	FINISHER	CARPETS
					
Jet	Gloss Black	Jet** or Light Oyster	Jet with Jet	Morse Code Aluminium	Jet
					
Latte	Gloss Black	Light Oyster	Espresso with Espresso	Morse Code Aluminium	Espresso

### VENEER OPTIONS

Carbon Fibre Veneer, Satin Ash Burl Veneer, Gloss Figured Ebony Veneer, Grey Figured Ebony Veneer, Satin Fine Line Veneer, Satin Rosewood Veneer or Gloss Burr Walnut Veneer

\*Suedecloth headlining available as an option.

\*\*Jet headlining available as an option.

# 5 CHOOSE YOUR INTERIOR

⚙️ Configure your vehicle at [jaguar.com](https://www.jaguar.com)



















Interior shown: Jet Taurus leather seats with Jet tonal stitch, Jet fascia, Morse Code Aluminium finisher, Gloss Black veneer and optional Jet headlining.



# PRESTIGE

## INTERIOR COLOUR COMBINATIONS

### STANDARD

1	2	3	4	5	6
SEAT WITH TONAL STITCH	veneer	HEADLINING MORZINE*	UPPER FACIA WITH TONAL STITCH	FINISHER	CARPETS
					
Jet with Jet	Gloss Black	Jet** or Light Oyster	Jet with Jet	Morse Code Aluminium	Jet
					
Latte with Latte	Gloss Black	Light Oyster	Espresso with Espresso	Morse Code Aluminium	Espresso
					
Light Oyster with Light Oyster	Gloss Black	Light Oyster	Oyster with Oyster	Morse Code Aluminium	Oyster

### VENEER OPTIONS

Carbon Fibre Veneer, Satin Ash Burl Veneer, Gloss Figured Ebony Veneer, Grey Figured Ebony Veneer, Satin Fine Line Veneer, Satin Rosewood Veneer or Gloss Burr Walnut Veneer

\*Suedecloth headlining available as an option.  
 \*\*Jet headlining available as an option.

# 5 CHOOSE YOUR INTERIOR

⚙️ Configure your vehicle at [jaguar.com](https://www.jaguar.com)

Interior shown: Latte Windsor leather seats with Latte tonal stitch, Espresso facia, Morse Code Aluminium finisher, Gloss Figured Ebony veneer and Light Oyster headlining.











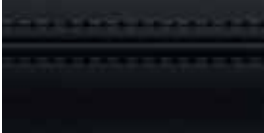

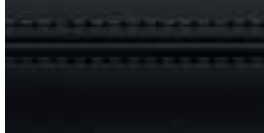













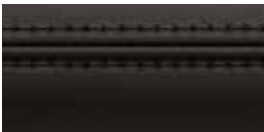

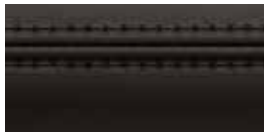

# PORTFOLIO

## INTERIOR COLOUR COMBINATIONS

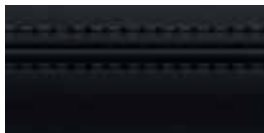
### STANDARD

1	2	3	4	5	6
SEAT WITH TONAL STITCH	veneer	HEADLINING MORZINE*	UPPER FACIA WITH TONAL STITCH	FINISHER	CARPETS
 Jet with Jet	 Gloss Figured Ebony	 Jet** or Light Oyster	 Jet with Jet	 Morse Code Aluminium	 Jet
 Latte with Latte	 Gloss Figured Ebony	 Light Oyster	 Espresso with Espresso	 Morse Code Aluminium	 Espresso
 Light Oyster with Light Oyster	 Gloss Figured Ebony	 Light Oyster	 Oyster with Oyster	 Morse Code Aluminium	 Oyster
 Espresso with Espresso	 Gloss Figured Ebony	 Light Oyster	 Espresso with Espresso	 Morse Code Aluminium	 Espresso
 Siena Tan with Siena Tan	 Gloss Figured Ebony	 Jet** or Light Oyster	 Jet with Jet	 Morse Code Aluminium	 Jet

### VENEER OPTIONS

Gloss Black Veneer, Carbon Fibre Veneer, Satin Ash Burl Veneer, Grey Figured Ebony Veneer, Satin Fine Line Veneer, Satin Rosewood Veneer or Gloss Burr Walnut Veneer

\*Suedecloth headlining available as an option.  
\*\*Jet headlining available as an option.

# 5 CHOOSE YOUR INTERIOR

⚙️ Configure your vehicle at [jaguar.com](https://www.jaguar.com)







Interior shown: Jet Taurus leather Sports seats with Jet technical mesh inserts and Light Oyster contrast stitch, Jet fascia with Light Oyster contrast stitch, Dark Morse Code Aluminium finisher, Gloss Black veneer and optional Light Oyster headlining.

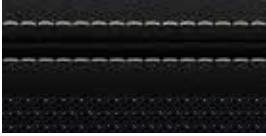

# R-SPORT

## INTERIOR COLOUR COMBINATIONS

### STANDARD

①	②	③	④	⑤	⑥
DUOTONE SEAT WITH CONTRAST STITCH	VENEER	HEADLINING MORZINE*	UPPER FACIA WITH CONTRAST STITCH	FINISHER	CARPETS
					
Jet/Jet with Light Oyster	Gloss Black	Jet or Light Oyster**	Jet with Light Oyster	Dark Morse Code Aluminium	Jet

### VENEER OPTIONS

Carbon Fibre Veneer, Satin Ash Burl Veneer, Gloss Figured Ebony Veneer, Grey Figured Ebony Veneer, Satin Fine Line Veneer, Satin Rosewood Veneer or Gloss Burr Walnut Veneer

\*Suedecloth headlining available as an option.

\*\*Light Oyster headlining available as an option.

# 5 CHOOSE YOUR INTERIOR

⚙️ Configure your vehicle at [jaguar.com](http://jaguar.com)

Interior shown: Jet and Light Oyster perforated Taurus leather Sports seats with Light Oyster contrast stitch, Jet fascia with Light Oyster contrast stitch, Dark Morse Code Aluminium finisher, optional Satin Fine Line veneer and optional Light Oyster headlining.

















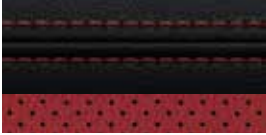

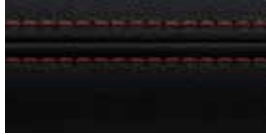







# R-SPORT

## INTERIOR COLOUR COMBINATIONS

### OPTIONS

1	2	3	4	5	6
<p>DUOTONE SEAT WITH CONTRAST STITCH</p>  <p>Jet/Jet with Light Oyster</p>	<p> veneer</p>  <p>Gloss Black</p>	<p>HEADLINING MORZINE*</p>  <p>Jet or Light Oyster**</p>	<p>UPPER FACIA WITH CONTRAST STITCH</p>  <p>Jet with Light Oyster</p>	<p>FINISHER</p>  <p>Dark Morse Code Aluminium</p>	<p>CARPETS</p>  <p>Jet</p>
 <p>Jet/Red with Red</p>	 <p>Gloss Black</p>	 <p>Jet or Light Oyster**</p>	 <p>Jet with Red</p>	 <p>Dark Morse Code Aluminium</p>	 <p>Jet</p>
 <p>Jet/Light Oyster with Light Oyster</p>	 <p>Gloss Black</p>	 <p>Jet or Light Oyster**</p>	 <p>Jet with Light Oyster</p>	 <p>Dark Morse Code Aluminium</p>	 <p>Jet</p>
 <p>Brogue/Brogue with Light Oyster</p>	 <p>Gloss Black</p>	 <p>Jet or Light Oyster**</p>	 <p>Jet with Light Oyster</p>	 <p>Dark Morse Code Aluminium</p>	 <p>Jet</p>

### VENEER OPTIONS

Carbon Fibre Veneer, Satin Ash Burl Veneer, Gloss Figured Ebony Veneer, Grey Figured Ebony Veneer, Satin Fine Line Veneer, Satin Rosewood Veneer or Gloss Burr Walnut Veneer

\*Suedecloth headlining available as an option.  
 \*\*Light Oyster headlining available as an option.

# 5 CHOOSE YOUR INTERIOR

⚙️ Configure your vehicle at [jaguar.com](https://www.jaguar.com)

Interior shown: Jet Taurus leather Sports seats with Jet Suedecloth inserts and Light Oyster contrast stitch, Jet fascia with Light Oyster contrast stitch, Dark Hex Aluminium finisher, Grey Figured Ebony veneer and Jet headlining.



# S

## INTERIOR COLOUR COMBINATIONS

### STANDARD

①	②	③	④	⑤	⑥
<b>DUOTONE SEAT WITH CONTRAST STITCH</b>	<b> veneer</b>	<b>HEADLINING MORZINE*</b>	<b>UPPER FACIA WITH CONTRAST STITCH</b>	<b>FINISHER</b>	<b>CARPETS</b>
					
Jet/Jet with Light Oyster	Grey Figured Ebony	Jet or Light Oyster**	Jet with Light Oyster	Dark Hex Aluminium	Jet
					
Red/Jet with Jet	Grey Figured Ebony	Jet or Light Oyster**	Jet with Red	Dark Hex Aluminium	Jet

### veneER OPTIONS

Gloss Black Veneer, Carbon Fibre Veneer, Satin Ash Burl Veneer, Gloss Figured Ebony Veneer, Satin Fine Line Veneer, Satin Rosewood Veneer or Gloss Burr Walnut Veneer

\*Suedecloth headlining available as an option.  
\*\*Light Oyster headlining available as an option.

# 5 CHOOSE YOUR INTERIOR

⚙️ Configure your vehicle at [jaguar.com](https://www.jaguar.com)

Interior shown: Light Oyster and Jet perforated Taurus leather Sports seats with Jet contrast stitch, Jet fascia with Light Oyster contrast stitch, Dark Hex Aluminium finisher, Grey Figured Ebony veneer and Jet headlining.



















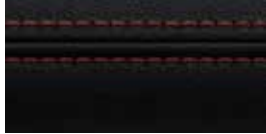

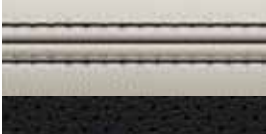





# S

## INTERIOR COLOUR COMBINATIONS

### OPTIONS

1	2	3	4	5	6
DUOTONE SEAT WITH CONTRAST STITCH	VENEER	HEADLINING MORZINE*	UPPER FACIA WITH CONTRAST STITCH	FINISHER	CARPETS
 Jet/Jet with Light Oyster	 Grey Figured Ebony	 Jet or Light Oyster**	 Jet with Light Oyster	 Dark Hex Aluminium	 Jet
 Red/Jet with Jet	 Grey Figured Ebony	 Jet or Light Oyster**	 Jet with Red	 Dark Hex Aluminium	 Jet
 Light Oyster/Jet with Jet	 Grey Figured Ebony	 Jet or Light Oyster**	 Jet with Light Oyster	 Dark Hex Aluminium	 Jet
 Brogue/Brogue with Light Oyster	 Grey Figured Ebony	 Jet or Light Oyster**	 Jet with Light Oyster	 Dark Hex Aluminium	 Jet

### VENEER OPTIONS

Gloss Black Veneer, Carbon Fibre Veneer, Satin Ash Burl Veneer, Gloss Figured Ebony Veneer, Satin Fine Line Veneer, Satin Rosewood Veneer or Gloss Burr Walnut Veneer

\*Suedecloth headlining available as an option.  
\*\*Light Oyster headlining available as an option.

# 5 CHOOSE YOUR INTERIOR

 Configure your vehicle at [jaguar.com](https://www.jaguar.com)

Gloss Black Veneer

Carbon Fibre Veneer

Satin Ash Burl Veneer

Gloss Figured Ebony Veneer



Grey Figured Ebony Veneer



Satin Fine Line Veneer



Satin Rosewood Veneer



Gloss Burr Walnut Veneer





# 6 CHOOSE YOUR JAGUAR ACCESSORIES

To find out more about the full range of retailer fit Jaguar Accessories, please refer to your retailer or go to [accessories.jaguar.com](http://accessories.jaguar.com)

Gloss Black Side Vent



Aluminium Paddle Shifters



Premium Carpet Mats

Rubber Mats



Gloss Black Mirror Caps





JaguarDrive Selector -  
Black Leather Top



iPad Holder



Roof Cross Bars



Roof Sports Box



Illuminated Sill Tread Plates



# TECHNICAL SPECIFICATIONS

 Configure your vehicle at [jaguar.com](http://jaguar.com)

		E-PERFORMANCE 2.0 LITRE i4 TURBOCHARGED DIESEL [RWD]		20d 2.0 LITRE i4 TURBOCHARGED DIESEL [RWD]		30d 3.0 LITRE V6 TWIN TURBOCHARGED DIESEL [RWD]	
<b>ENGINES</b>							
Capacity	cc	1,999		1,999		2,993	
Maximum power	EEC-PS (kW)	163 (120)		180 (132)		300 (221)	
@rev/min	rpm	4,000		4,000		4,000	
Maximum torque	EEC-Nm (lb.ft.)	380		430		700	
@rev/min	rpm	1,750-2,500		1,750-2,500		2,000	
<b>PERFORMANCE</b>							
		MANUAL	AUTOMATIC	MANUAL	AUTOMATIC	AUTOMATIC	
0-100 km/h	seconds	8.7	8.7	8.0	8.1	6.2	
0-60 mph	seconds	8.2	8.2	7.5	7.7	5.8	
Top speed	km/h (mph)	229 (142)	227 (141)	230 (143)	229 (142)	250 (155)	
<b>FUEL CONSUMPTION<sup>1</sup></b>							
		MANUAL	AUTOMATIC	MANUAL	AUTOMATIC	AUTOMATIC	
Urban	l/100km (mpg)	4.8 (58.9)	5.1 (55.4)	5.1 (55.4)	5.2 (54.3)	6.6 (42.8)	
Extra Urban	l/100km (mpg)	3.6 (78.5)	3.6 (78.5)	3.9 (72.4)	3.8 (74.3)	4.8 (58.9)	
Combined	l/100km (mpg)	4.0 (70.6)	4.1 (68.9)	4.3 (65.7)	4.3 (65.7)	5.5 (51.4)	
Carbon dioxide emissions	g/km	104	109	114	114	144	
Tank capacity (usable)	ltr approx.	55	55	66	66	66	
<b>DIMENSIONS</b>							
Overall length	mm	4,954		4,954		4,954	
Overall width (inc. mirrors)	mm	2,091		2,091		2,091	
Overall width (exc. mirrors)	mm	1,880		1,880		1,880	
Overall height	mm	1,457		1,457		1,457	
Wheelbase	mm	2,960		2,960		2,960	
Front track	mm	1,605 (1,597 20" wheels)		1,605 (1,597 20" wheels)		1,605 (1,597 20" wheels)	
Rear track	mm	1,594 (1,586 20" wheels)		1,594 (1,586 20" wheels)		1,594 (1,586 20" wheels)	
Ground clearance	mm	116		116		110	
Turning circle diameter (kerb to kerb)	m	11.61		11.61		11.61	
Boot volume	litres	540		540		540	
<b>WEIGHT<sup>2</sup></b>							
		MANUAL	AUTOMATIC	MANUAL	AUTOMATIC	AUTOMATIC	
Kerb weight from	kg	1,545	1,555	1,585	1,595	1,750	
Gross vehicle weight	kg	2,190	2,190	2,250	2,250	2,350	
<b>ENGINE AVAILABILITY</b>							
Pure		●		●		—	
Prestige		●		●		●	
Portfolio		●		●		●	
R-Sport		●		●		●	
S		—		—		—	

● Available — Not Available

<sup>1</sup>The figures provided are as a result of official manufacturer's tests in accordance with EU legislation. A vehicle's actual fuel consumption may differ from that achieved in such tests and these figures are for comparative purposes only.

<sup>2</sup>Weights reflect vehicles to standard specifications. Optional extras increase weight.

ENGINES		25t JAGUAR 2.0 LITRE i4 240 TURBOCHARGED PETROL [AUTO]	35t 3.0 LITRE V6 SUPERCHARGED PETROL [AUTO]	S 3.0 LITRE V6 SUPERCHARGED PETROL [AUTO]		
Capacity	cc	1,999	2,995	2,995		
Maximum power	EEC-PS (kW)	240 (177)	340 (250)	380 (280)		
@rev/min	rpm	5,500	6,500	6,500		
Maximum torque	EEC-Nm (lb.ft.)	340	450	450		
@rev/min	rpm	1,750-4,000	4,500	4,500		
PERFORMANCE		RWD	RWD	AWD	RWD	AWD
0-100 km/h	seconds	7.0	5.4	5.4	5.3	5.3
0-60 mph	seconds	6.7	5.2	5.1	5.1	5.0
Top speed	km/h (mph)	248 (154)	250 (155)	250 (155)	250 (155)	250 (155)
FUEL CONSUMPTION <sup>1</sup>		RWD	RWD	AWD	RWD	AWD
Urban	l/100km (mpg)	10.5 (26.9)	11.7 (24.1)	11.9 (23.7)	11.7 (24.1)	11.9 (23.7)
Extra Urban	l/100km (mpg)	5.8 (48.7)	6.3 (44.8)	6.7 (42.2)	6.3 (44.8)	6.7 (42.2)
Combined	l/100km (mpg)	7.5 (37.7)	8.3 (34.0)	8.6 (32.9)	8.3 (34.0)	8.6 (32.9)
Carbon dioxide emissions	g/km	179	198	204	198	204
Tank capacity (usable)	ltr approx.	74	74	74	74	74
DIMENSIONS		RWD	RWD	AWD	RWD	AWD
Overall length	mm	4,954	4,954	4,954	4,954	4,954
Overall width (inc. mirrors)	mm	2,091	2,091	2,091	2,091	2,091
Overall width (exc. mirrors)	mm	1,880	1,880	1,880	1,880	1,880
Overall height	mm	1,457	1,457	1,457	1,457	1,457
Wheelbase	mm	2,960	2,960	2,960	2,960	2,960
Front track	mm	1,605 (1,597 20" wheels)	1,605 (1,597 20" wheels)	1,605 (1,597 20" wheels)	1,605 (1,597 20" wheels)	1,605 (1,597 20" wheels)
Rear track	mm	1,594 (1,586 20" wheels)	1,594 (1,586 20" wheels)	1,594 (1,586 20" wheels)	1,594 (1,586 20" wheels)	1,594 (1,586 20" wheels)
Ground clearance	mm	116	116	116	116	116
Turning circle diameter (kerb to kerb)	m	11.61	11.61	11.61	11.61	11.61
Boot volume	litres	540	540	540	540	540
WEIGHT <sup>2</sup>		RWD	RWD	AWD	RWD	AWD
Kerb weight from	kg	1,590	1,710	1,760	1,710	1,760
Gross vehicle weight	kg	2,210	2,330	2,370	2,330	2,370
ENGINE AVAILABILITY		RWD	RWD	AWD	RWD	AWD
Pure		●	●	—	—	—
Prestige		●	●	—	—	—
Portfolio		●	●	—	—	—
R-Sport		●	●	—	—	—
S		—	—	●	●	●

# DIMENSIONS

**Overall Width** (inc mirrors) 2,091mm

**Overall Width** (exc mirrors) 1,880mm

**Boot Volume** 540 Litres

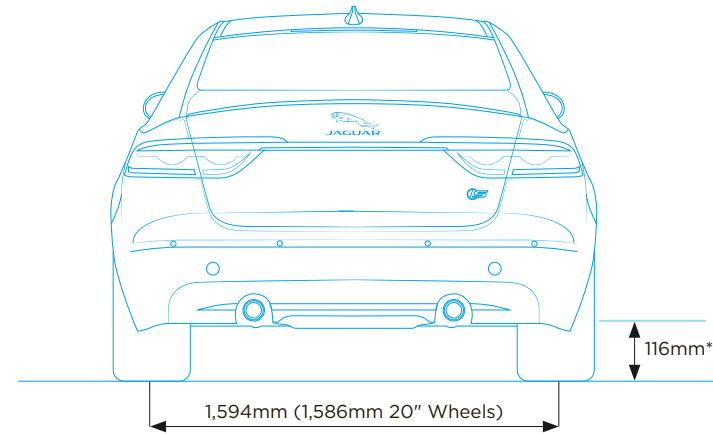
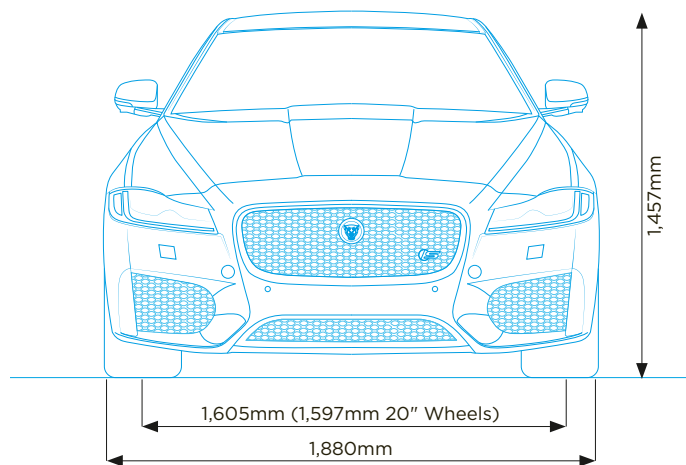



**Turning Circle**

Kerb to Kerb 11.61m

Wall to Wall 11.94m

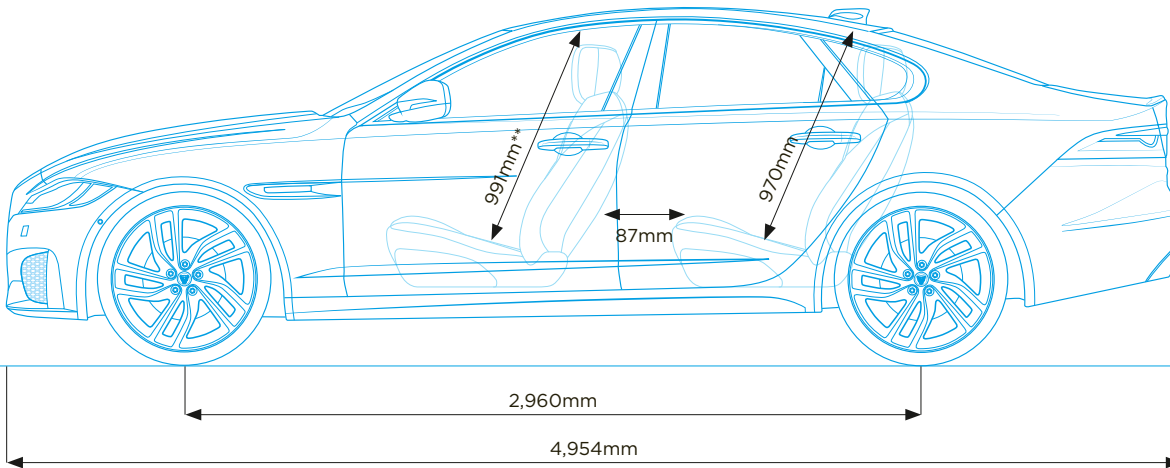
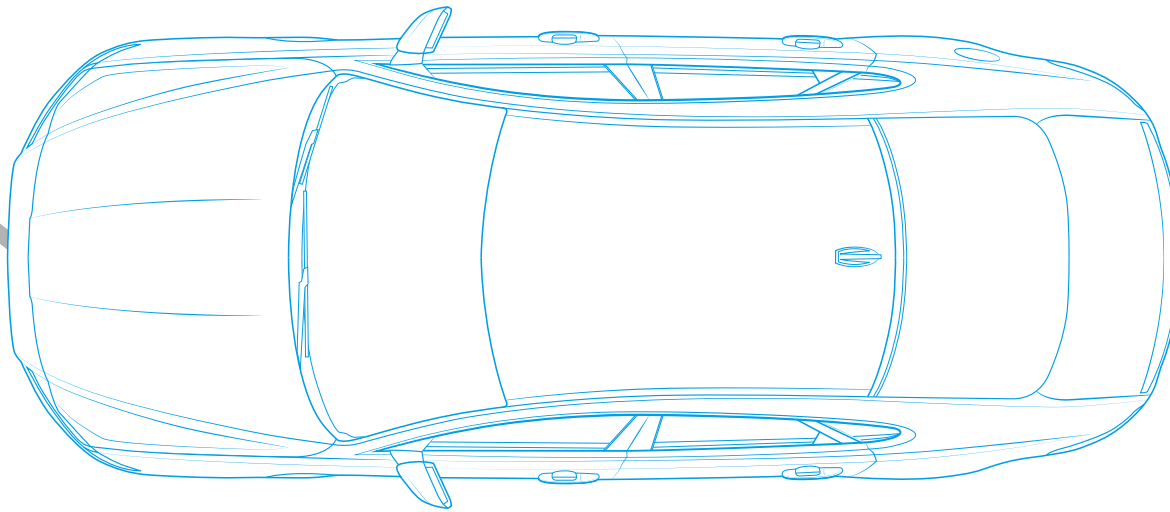

\*110mm for 30d 3.0 litre V6 twin turbocharged diesel.

\*\*953mm with optional sunroof.

Dimensions were measured with vehicle at unladen weight.  
(measured by VDA standard test method using 200 x 100 x 50mm blocks.)



## JAGUAR EXPERIENCE

There's no better way to get to know XF and Jaguar than by taking a drive. Jaguar Experience offers a range of unique opportunities to really find out what it feels like to get the most out of a Jaguar. Our track experiences allow you to push yourself, XF and other cars from the incredible Jaguar range to the limit. Jaguar Experience also offers the opportunity to see a Jaguar brought to life during a tour of one of our UK manufacturing facilities. Find out more by visiting [jaguar.com/experience](http://jaguar.com/experience)



Follow us on:



Facebook.com



Instagram.com



Twitter.com



Youtube.com



# THE WORLD OF JAGUAR

Choose an XF and you're joining the exciting World of Jaguar. It makes owning and driving carefree and easy, as well as providing a range of exclusive services and lifestyle products.



## JAGUAR CARE\*

What makes XF totally irresistible is that every new car comes with Jaguar Care, which includes an unlimited mileage, three year warranty and three years' free standard servicing. So however far you drive, your journeys will be worry free. To find out more about XF's superbly competitive Jaguar Care programme, please go to [jaguar.com/jaguarcare](http://jaguar.com/jaguarcare)



## SERVICING

XF has been designed to keep servicing costs to a minimum - for example, the new Ingenium diesel engines can achieve an incredible 34,000km or 2 years\*\* between services due to intelligent design and advanced oil technology.

## GENUINE PARTS

Jaguar Genuine Parts are designed, tested and manufactured to our uncompromising standards for quality, fit and durability. Each part is engineered specifically for your XF to contribute to optimum performance and to help maximise its lifespan.



## FLEET & BUSINESS

Jaguar is dedicated to being the premium manufacturer of choice for fleets and businesses by providing a highly attractive car range and exemplary customer service. Jaguars are dynamic and distinctive cars that help companies express the unique character and personality of their business. We are committed to providing totally customer-focused aftersales services, which keeps every Jaguar car on the move and in top condition, ensuring that they perform to the highest standard and in the most cost-efficient way for businesses, visit [jaguar.com/fleet-and-business](http://jaguar.com/fleet-and-business)





#### JAGUAR FINANCIAL SERVICES

Effortless performance and style come as standard with every Jaguar. Jaguar Financial Services makes buying one just as simple and rewarding. New or used, for personal or business use, we have an option that puts you in complete control. Please speak to your local Jaguar retailer to find out more.



#### JAGUAR ASSISTANCE

Jaguar Assistance provides assistance in motoring emergencies, from immobilisation due to breakdown or accident to minor problems such as punctures. You can rely on our roadside assistance, whatever the situation, wherever you happen to be.

#### LOW INSURANCE

XF's key components are easily accessible for time-efficient service and repair and to minimise scheduled maintenance and repair costs. With a focus on lower repair costs, XF delivers competitive insurance group ratings<sup>†</sup>. To find out more about the compelling business case for XF, please contact your local Jaguar retailer.



#### JAGUAR MAGAZINE

Jaguar Magazine is the official magazine of Jaguar Cars. It features the new Jaguar F-TYPE, XJ, XE and XF, and the worlds of luxury, style, design and travel.

#### JAGUAR COLLECTION

The latest range from the Jaguar Collection has been crafted with the same design execution and attention to detail that goes into all of our cars. This is evident in our clothing range, premium leather items and luxury travel goods. To celebrate Jaguar's heritage we also have a collection that honours past achievements and features race inspired gift items and apparel. To find out more, visit the online shop at [www.jaguar.co.uk/shop](http://www.jaguar.co.uk/shop)

\*Selected European Markets only.  
\*\*Market and driving style dependent.  
†Manufacturer's estimate.

# GLOSSARY

## A

### ADAPTIVE FULL LED HEADLIGHTS

Adaptive Headlights automatically adjust to follow steering inputs, casting light where needed. They will angle the beam when indicating, as well as working in conjunction with Automatic High Beam Assist to prevent your lights from dazzling oncoming traffic.

### ADAPTIVE SPEED LIMITER

The Adaptive Speed Limiter, when selected, will assist in limiting vehicle speed to the speed limits as recognised by the Traffic Sign Recognition system.

### ADVANCED PARK ASSIST

Advanced Park Assist offers all the functions of Park Assist (see pg. 50) plus 360° Park Distance Control with virtual object tracking. This gives confidence in confined situations, at speeds up to 16km/h.

### AUX CONNECTION

Auxiliary (AUX) connections allow for the convenient input of audio signals from personal devices.

## C

### Cd.

The Cd. value is the drag coefficient of the car. It gives an indication of the vehicle's aerodynamic qualities. The lower the value, the more aerodynamically efficient the vehicle's design.

### CONFIGURABLE INTERIOR MOOD LIGHTING

Configurable Interior Mood Lighting highlights a number of your Jaguar's key functional and styling features and allows adjustment of the ambient light. Choose from a range of 10 colours.

### CONNECTIVITY PACKAGE

A connectivity package is a bundle of applications and technologies that enhances your connection with your Jaguar and with the world by giving internet connectivity, optimised in-car applications and remote access to your car.

## D

### DAB RADIO

The DAB (Digital Audio Broadcast) radio system offers clarity of reception, a wide choice of stations and live text information about the station, show and song you are listening to.

### DAMPERS/DAMPING

Dampers absorb forces acting on the suspension for greater ride comfort and control. Dampers are also known as shock absorbers.

### DEAD RECKONING

Dead Reckoning uses sensors to measure vehicle direction, wheel rotation and inclination. These measurements are calibrated up to 40 times per second to ensure accurate placement of the vehicle even when no GPS signal is available.

### DRAG COEFFICIENT

The drag coefficient measures how aerodynamic a car is. See definition of Cd.

## E

### ECO MODE

Eco Mode encourages fuel efficient driving by reducing throttle sensitivity, selecting more economical engine mapping and, on manual vehicles, advising of gearshifts. It also reduces fuel consumption by reducing the energy demands placed on the engine by climate control and audio systems.

## F

### FORWARD ALERT

Should a potential collision be detected Forward Alert gives an audible warning and a visual warning in the instrument cluster.

### FOUR-ZONE CLIMATE CONTROL

Automatic four-zone climate control that can be optimised for individual occupants.

## G

### GPS

The Global Positioning System (GPS) uses satellites to determine the car's position. By cross-referencing this with road maps stored in its memory, the navigation system provides route guidance and tracks the car's location.

## I

### INCONTROL SECURE

InControl Secure provides stolen vehicle tracking. Tracking technology alerts you to an attempted theft and shares your vehicle's location with the authorities for a timely recovery.

### INGENIUM ENGINES

Ingenium engines are manufactured in the UK at Jaguar Land Rover's state-of-the-art Engine Manufacturing Centre in the West Midlands. The aluminium engines feature lightweight construction, with stiff cylinder blocks and decoupled injectors, which ensure low levels of vibration and noise intrusion, further enhancing the driver experience. A series of advanced technologies reduce internal friction, improve refinement and enhance overall performance. In addition, Selective Catalytic Reduction and a new low-pressure exhaust gas recirculation system significantly reduce both CO<sub>2</sub> and NO<sub>x</sub> emissions on diesel engines.

### INTERIOR MOOD LIGHTING

Interior mood lighting highlights many of the cabin's key features and design details in a relaxing soft phosphor blue glow.

### INTELLIGENT STOP/START

Stop/Start is a technology that stops the engine when it is not needed, improving the fuel economy and reducing the car's CO<sub>2</sub> emissions. The engine will restart as soon as the driver's foot comes off the brake pedal. The engine will be operating at full capacity before the driver's foot has touched the accelerator pedal.

## J

### JAGUAR SIGNATURE 'J' BLADE DAYTIME RUNNING LIGHTS

J-Blade Daytime Running Lights are separate LED running lights, in a distinctive 'J' shape, built into the headlights. They emphasise Jaguar's striking on road style.

### JAGUARDRIVE CONTROL

Interacts with the Dynamic Stability Control system, engine and transmission management systems to alter the characteristics of the engine mapping, gearshifts and brakes. It offers different modes designed to optimise the vehicle's response to particular driving conditions and styles.

### JAGUARDRIVE SELECTOR

The JaguarDrive Selector rises from the centre console on start up. It is a rotary shifter used with automatic transmissions that allows you to quickly shift between drive modes.

## L

### LED HEADLIGHTS WITH LED 'J' BLADE DAYTIME RUNNING LIGHTS

Multiple powerful LED emitters give a clearer light in low light conditions. Further complemented with LED J-Blade Daytime Running Lights incorporating LED Direction Indicators. These lights also integrate Jaguar's Adaptive Lighting and Auto High Beam Assist systems.

## M

### MHL CONNECTION

A Mobile High-Definition Link (MHL) enables connection between a personal device and the InControl infotainment system. It is designed for seamless transfer of audio-visual data.

### 10.2 INCH MULTI-TOUCH DISPLAY

The Multi-touch functionality of InControl Touch Pro's 10.2 inch Display allows the screen to recognise multiple points of contact. This provides direct control of the system's features in a more natural, intuitive way, enabling gestures such as pinch and zoom.



## S

### SATELLITE VIEW

Satellite View allows you to view satellite imagery as an optional view mode for the navigation system.

### SD CARD

A Secure Digital (SD) Card is a flash memory card used for storing large amounts of data in a compact form.

### SOLID STATE DRIVE

Solid State Drives are storage devices with no moving parts designed for rapid retrieval of large quantities of data.

## V

### 12.3 INCH VIRTUAL INSTRUMENT DISPLAY

The 12.3 inch Virtual Instrument Display is a TFT (Thin Film Transistor) screen that replaces the traditional instrument cluster. It displays a wide range of key driving information. Four graphical themes and a 3D map view are available.

## W

### WINTER MODE

By selecting Winter Mode, the system automatically dampens acceleration and applies more gradual torque for improved traction in slippery conditions.

## X

### XENON HEADLIGHTS

Bi-function Xenon headlights offer improved illumination and feature LED J-Blade Daytime Running Lights for a striking on road style.

Meridian is the registered trademark of Meridian Audio Limited.

AdBlue® is the registered trademark of the Verband der Automobilindustrie e. V. (VDA).

The Bluetooth® word mark and logos are owned by the Bluetooth SIG, Inc. and any use of such marks by Jaguar Land Rover Limited is under licence.

iPod, iPod touch and iPad are trademarks of Apple Inc, registered in the US and other countries.

## IMPORTANT NOTICE

Jaguar Land Rover Limited is constantly seeking ways to improve the specification, design and production of its vehicles and alterations take place continually. While every effort is made to produce up-to-date literature, this brochure should not be regarded as an infallible guide to current specifications, nor does it constitute an offer for the sale of any particular vehicle. Distributors and Retailers are not agents of Jaguar Land Rover Limited by any express or implied undertaking or representation. Comparisons are based on manufacturer's own data and testing.

## COLOURS

Print and online colours are representative only.

## ENVIRONMENTAL INNOVATION AT JAGUAR

Jaguar is proud to continue the company's tradition with its approach to Environmental Innovation. From the choice of lightweight materials and lean production methods to the efficiency of its engines and designs, Jaguar is committed to operating as a more sustainable business and reducing its overall environmental impact.

Jaguar's flagship XJ model was the first in the company to achieve ISO14040, the international standard for vehicle 'life cycle assessment'. This certification measures the environmental impact of XJ from component material sourcing and manufacturing process, through driving 200,000 km. But that's not all. Every new Jaguar is designed to be 85% Recyclable/Reusable and 95% Recoverable at the end of the vehicle's life.

The all-new XF, XE, XJ and F-TYPE's innovative use of lightweight aluminium, which incorporates up to 50% closed-loop recycled material from the manufacturing process of the body structures, provides considerable performance benefits. This includes improved fuel consumption and less CO<sub>2</sub> emissions during the use phase of the Life Cycle due to lighter structures. Our on-going target is to ensure scrap aluminium reclaimed from our stamping process is to be segregated and recycled through a closed loop system and re-melted into the same grade quality sheet, therefore reducing CO<sub>2</sub> emissions during the production phase of the Life Cycle. Jaguar is committed to reducing dependency on fossil fuels, using fewer resources and creating less waste as part of our approach to sustainability excellence.

The company plan includes 25% reduction targets in operating and tailpipe CO<sub>2</sub> emissions, waste to landfill, logistics efficiencies (15%) and water consumption (10%), all based on per vehicle built since 2007. In addition the manufacturing assembly CO<sub>2</sub> emissions of each Jaguar built in the UK since 2009 is 100% offset. For each tonne of CO<sub>2</sub> emitted in the assembly process, Jaguar invests in projects that reduce an equivalent tonne of CO<sub>2</sub> elsewhere. Taking into account the company's global sales growth and increased investment in more efficient operating facilities, we are proud to have delivered and in some cases exceeded our Environmental Innovation targets as planned for 2012. And we are on track to meet our 25% reduction in joint European fleet average tailpipe CO<sub>2</sub> emissions by 2015.

Looking forward, we have developed our 2020 vision for sustainable business growth that focuses on continued improvements in tailpipe CO<sub>2</sub> emissions, operational carbon neutrality and zero waste. To date the company has offset over 6 million tonnes of CO<sub>2</sub>, provided over 4,000 direct jobs in 60 emissions reduction projects in 17 countries and improved the lives of over 1 million people in our global cook stoves emissions reduction programme.

But it doesn't stop there. Our manufacturing facilities have been certified to ISO14001 since 1998 and we are credited to Platinum Plus level in the UK's Business in the Community Corporate Responsibility Index.

Castrol EDGE™ Professional is exclusively recommended by Jaguar.



Jaguar Land Rover Limited  
Registered Office: Abbey Road, Whitley,  
Coventry, CV3 4LF, United Kingdom  
Registered in England Number: 1672070  
jaguar.com

VEHICLE SHOWN FRONT AND BACK COVERS: XF S IN GLACIER WHITE WITH 20" LABYRINTH ALLOY WHEELS, OPTIONAL LED HEADLIGHTS AND OPTIONAL BLACK PACK

Printed in England September 2015/16MY  
JLM/24/02/30/0915

